



ConnectX[®]-3 Pro VPI Single and Dual QSFP+ Port Adapter Card User Manual

P/N:
MCX353A-FCCT, MCX354A-FCCT

Rev 1.5

NOTE:

THIS HARDWARE, SOFTWARE OR TEST SUITE PRODUCT (“PRODUCT(S)”) AND ITS RELATED DOCUMENTATION ARE PROVIDED BY MELLANOX TECHNOLOGIES “AS-IS” WITH ALL FAULTS OF ANY KIND AND SOLELY FOR THE PURPOSE OF AIDING THE CUSTOMER IN TESTING APPLICATIONS THAT USE THE PRODUCTS IN DESIGNATED SOLUTIONS. THE CUSTOMER’S MANUFACTURING TEST ENVIRONMENT HAS NOT MET THE STANDARDS SET BY MELLANOX TECHNOLOGIES TO FULLY QUALIFY THE PRODUCT(S) AND/OR THE SYSTEM USING IT. THEREFORE, MELLANOX TECHNOLOGIES CANNOT AND DOES NOT GUARANTEE OR WARRANT THAT THE PRODUCTS WILL OPERATE WITH THE HIGHEST QUALITY. ANY EXPRESS OR IMPLIED WARRANTIES, INCLUDING, BUT NOT LIMITED TO, THE IMPLIED WARRANTIES OF MERCHANTABILITY, FITNESS FOR A PARTICULAR PURPOSE AND NONINFRINGEMENT ARE DISCLAIMED. IN NO EVENT SHALL MELLANOX BE LIABLE TO CUSTOMER OR ANY THIRD PARTIES FOR ANY DIRECT, INDIRECT, SPECIAL, EXEMPLARY, OR CONSEQUENTIAL DAMAGES OF ANY KIND (INCLUDING, BUT NOT LIMITED TO, PAYMENT FOR PROCUREMENT OF SUBSTITUTE GOODS OR SERVICES; LOSS OF USE, DATA, OR PROFITS; OR BUSINESS INTERRUPTION) HOWEVER CAUSED AND ON ANY THEORY OF LIABILITY, WHETHER IN CONTRACT, STRICT LIABILITY, OR TORT (INCLUDING NEGLIGENCE OR OTHERWISE) ARISING IN ANY WAY FROM THE USE OF THE PRODUCT(S) AND RELATED DOCUMENTATION EVEN IF ADVISED OF THE POSSIBILITY OF SUCH DAMAGE.



Mellanox Technologies
 350 Oakmead Parkway Suite 100
 Sunnyvale, CA 94085
 U.S.A.
www.mellanox.com
 Tel: (408) 970-3400
 Fax: (408) 970-3403

© Copyright 2015. Mellanox Technologies. All Rights Reserved.

Mellanox®, Mellanox logo, BridgeX®, CloudX logo, Connect-IB®, ConnectX®, CoolBox®, CORE-Direct®, GPUDirect®, InfiniHost®, InfiniScale®, Kotura®, Kotura logo, Mellanox Federal Systems®, Mellanox Open Ethernet®, Mellanox ScalableHPC®, Mellanox Connect Accelerate Outperform logo, Mellanox Virtual Modular Switch®, MetroDX®, MetroX®, MLNX-OS®, Open Ethernet logo, PhyX®, SwitchX®, TestX®, The Generation of Open Ethernet logo, UFM®, Virtual Protocol Interconnect®, Voltaire® and Voltaire logo are registered trademarks of Mellanox Technologies, Ltd.

Accelio™, CyPU™, FPGADirect™, HPC-X™, InfiniBridge™, LinkX™, Mellanox Care™, Mellanox CloudX™, Mellanox Multi-Host™, Mellanox NEO™, Mellanox PeerDirect™, Mellanox Socket Direct™, Mellanox Spectrum™, NVMeDirect™, StPU™, Spectrum logo, Switch-IB™, Unbreakable-Link™ are trademarks of Mellanox Technologies, Ltd.

All other trademarks are property of their respective owners.

Table of Contents

Table of Contents	3
List of Tables	6
List of Figures	7
Revision History	8
About this Manual	9
Intended Audience	9
Related Documentation	9
Document Conventions	9
Technical Support	10
Firmware and Software Updates	10
Chapter 1 Introduction	11
1.1 Product Overview	11
1.2 Features and Benefits	12
1.3 Operating Systems/Distributions	13
1.4 Connectivity	13
Chapter 2 Interfaces	14
2.1 InfiniBand Interface	14
2.2 Ethernet Interface	14
2.3 PCI Express Interface	15
2.4 I2C-compatible Interface	15
2.5 LED Interface	15
Chapter 3 Hardware Installation	16
3.1 System Requirements	16
3.1.1 Hardware	16
3.1.2 Operating Systems/Distributions	16
3.1.3 Software Stacks	16
3.2 Safety Precautions	16
3.3 Pre-installation Checklist	16
3.4 Bracket Installation Instructions	16
3.4.1 Removing the Existing Bracket	17
3.4.2 Installing the New Bracket	17
3.5 Card Installation Instructions	18
3.6 Cables and Modules	19
3.6.1 Cable Installation	19
3.7 Identify the Card in Your System	20
3.7.1 On Windows	20
3.7.2 On Linux	21
Chapter 4 Driver Installation	22
4.1 Linux Driver	22
4.1.1 Hardware and Software Requirements	22
4.1.2 Downloading Mellanox OFED	22

4.1.3	Installing Mellanox OFED	23
4.1.3.1	Pre-installation Notes	23
4.1.3.2	Installation Script	24
4.1.3.3	mlnxofedinstall Return Codes	25
4.1.3.4	Installation Procedure	26
4.1.4	Installation Results	33
4.1.5	Post-installation Notes	35
4.1.6	Updating Firmware After Installation	35
4.1.7	Uninstalling Mellanox OFED	37
4.1.8	Port Type Management on Linux	37
4.1.9	Auto Sensing	37
4.1.9.1	Enabling Auto Sensing	38
4.2	Windows Driver	38
4.2.1	Downloading MLNX_WinOF	38
4.2.2	Extracting Files Without Running Installation	39
4.2.3	Installing MLNX_WinOF	41
4.2.3.1	Attended Installation	41
4.2.3.2	Unattended Installation	47
4.2.4	Upgrading MLNX_WinOF	47
4.2.5	Installation Results	48
4.2.6	OpenSM Activation	48
4.2.7	Uninstalling MLNX_WinOF	49
4.2.7.1	Attended Uninstall	49
4.2.7.2	Unattended Uninstall	49
4.2.8	Assigning Port IP After Installation	49
4.2.9	Port Type Management on Windows	51
4.3	Performance Tuning	53
4.4	VMware Driver	53
4.4.1	Installing Mellanox InfiniBand OFED Driver for VMware vSphere	53
4.4.2	Uninstalling Mellanox InfiniBand OFED Driver	54
4.5	FlexBoot	54
Chapter 5	Updating Adapter Card Firmware	55
Chapter 6	Troubleshooting	57
6.1	General	57
6.2	Linux	58
6.3	Windows	59
Chapter 7	Specifications	60
7.1	MCX353A-FCCT Specifications	60
7.2	MCX354A-FCCT Specifications	61
7.3	Adapter Led Operations	63
7.4	Board Mechanical Drawing and Dimensions	64
7.5	Bracket Mechanical Drawing	66
7.6	Regulatory Statements	67
Appendix A	Interface Connectors Pinout	68
A.1	QSFP+ Connector Pinout	68

	A.2	PCI Express x8 Connector Pinout	69
	A.3	I2C-compatible Connector Pinout	70
Appendix B		Finding the GUID/MAC and Serial Number on the Adapter Card	71
Appendix C		Safety Warnings	72
Appendix D		Avertissements de sécurité d’installation (Warnings in French)	74
Appendix E		Sicherheitshinweise (Warnings in German)	76
Appendix F		Advertencias de seguridad para la instalación (Warnings in Spanish)	78

List of Tables

Table 1:	Revision History Table	8
Table 2:	Documents List	9
Table 3:	Single and Dual-port FDR Adapter Cards.	11
Table 4:	Features	12
Table 5:	Software and Hardware Requirements	22
Table 6:	mlnxofedinstall Return Codes	26
Table 7:	Supported ConnectX Port Configurations.	37
Table 8:	Software and Hardware Requirements	38
Table 9:	MCX354A-FCCT Specifications Table	60
Table 10:	MCX354A-FCCT Specifications Table	61
Table 11:	Physical and Logical Link Indications (InfiniBand Mode).	63
Table 12:	Physical and Logical Link Indication (Ethernet Mode)	63

List of Figures

Figure 1:	MCX354A-FCCT Card	14
Figure 2:	Bracket Screws	17
Figure 3:	EMI Fingers (Example)	17
Figure 4:	Placing the Bracket on the Card	18
Figure 5:	PCI Device	20
Figure 6:	Support Download Assistant	56
Figure 7:	Mechanical Drawing of the Single-port MCX353A-FCCT Adapter Card	64
Figure 8:	Mechanical Drawing of the Dual-port MCX354A-FCCT Adapter Card	65
Figure 9:	Dual-port Bracket	66
Figure 10:	Single-port Bracket	67
Figure 11:	Connector and Cage Views	68
Figure 12:	PCIe Connector Pinout	70
Figure 13:	Compatible Connector Plug and Pinout	70
Figure 14:	Card Product Label	71

Revision History

This document was printed on December 30, 2015.

Table 1 - Revision History Table

Date	Rev	Comments/Changes
December 2015	1.5	<ul style="list-style-type: none"> Updated non-operational temperature in the following specifications tables: <ul style="list-style-type: none"> Section 7.1, "MCX353A-FCCT Specifications" on page 60. Section 7.2, "MCX354A-FCCT Specifications" on page 61
October 2015	1.4	<ul style="list-style-type: none"> Updated Device ID. See Product Overview on page 11.
May 2014	1.3	<ul style="list-style-type: none"> Added note on bracket replacement. See Section 3.4, "Bracket Installation Instructions," on page 16.
April 2014	1.2	<ul style="list-style-type: none"> Added Section 4.3, "Performance Tuning," on page 53 Added <i>Performance Tuning Guidelines</i> to "Related Documentation" on page 9
December 2013	1.1	<ul style="list-style-type: none"> Added the following note to Chapter 5, "Updating Adapter Card Firmware" on page 55 <ul style="list-style-type: none"> - Note: The shown versions and/or parameter values in the example below may not reflect the latest or actual values for this product, and are included here for illustration purposes only. Specified max power available through QSFP+ ports in all specification tables. See Chapter 7, "Specifications" on page 60. Updated link to approved cables list in all specification tables. See Chapter 7, "Specifications" on page 60.
June 2013	1.0	First Release

About this Manual

This *User Manual* describes Mellanox Technologies ConnectX®-3 Pro VPI Single and Dual QSFP+ port PCI Express x8 adapter cards. It provides details as to the interfaces of the board, specifications, required software and firmware for operating the board, and relevant documentation.

Intended Audience

This manual is intended for the installer and user of these cards.

The manual assumes basic familiarity with InfiniBand and Ethernet network and architecture specifications.

Related Documentation

Table 2 - Documents List

<i>Mellanox Firmware Tools (MFT) User Manual</i> Document no. 2204UG	User Manual describing the set of MFT firmware management tools for a single node. See http://www.mellanox.com => Products => Software => Firmware Tools
<i>Mellanox OFED for Linux User Manual</i> Document no. 2877	User Manual describing OFED features, performance, InfiniBand diagnostic, tools content and configuration. See http://www.mellanox.com => Products => Software => Linux SW/Drivers => Mellanox OpenFabrics Enterprise Distribution for Linux (MLNX_OFED)
<i>WinOF VPI for Windows User Manual</i> Document no.3280	User Manual describing WinOF features, performance, InfiniBand diagnostic, tools content and configuration. See http://www.mellanox.com => Products => Software => Windows SW/Drivers
<i>Performance Tuning Guidelines for Mellanox Network Adapters</i> Document no. 3368	Manual describes important tuning parameters and settings that can improve performance for Mellanox drivers.
<i>Mellanox InfiniBand OFED Driver for VMware vSphere 5.x User Manual</i> Document no. 3464	User Manual describing OFED driver for VMware features, performance, InfiniBand diagnostic, tools content and configuration
<i>IBTA Specification Release 1.2.1</i>	InfiniBand Architecture Specification
<i>IEEE Std 802.3 Specification</i>	This is the IEEE Ethernet specification http://standards.ieee.org/getieee802
<i>PCI Express 3.0 Specifications</i>	Industry Standard PCI Express 3.0 Base and Card Electromechanical Specifications

Document Conventions

When discussing memory sizes, MB and MBytes are used in this document to mean size in mega Bytes. The use of Mb or Mbits (small b) indicates size in mega bits. IB is used in this document to mean InfiniBand. In this document PCIe is used to mean PCI Express.

Technical Support

Customers who purchased Mellanox products directly from Mellanox are invited to contact us through the following methods.

- URL: <http://www.mellanox.com> => Support
- E-mail: support@mellanox.com
- Tel: +1.408.916.0055

Customers who purchased Mellanox M-1 Global Support Services, please see your contract for details regarding Technical Support.

Customers who purchased Mellanox products through a Mellanox approved reseller should first seek assistance through their reseller.

Firmware and Software Updates

The Mellanox support downloader contains software, firmware and knowledge database information for Mellanox products. Access the database from the Mellanox Support web page,

<http://www.mellanox.com> => Support

or use the following link to go directly to the Mellanox Support Download Assistant page,

<http://www.mellanox.com/supportdownloader/>.

1 Introduction

This is the User Guide for Mellanox Technologies VPI adapter cards based on the ConnectX®-3 Pro VPI integrated circuit device. These adapters connectivity provide the highest performing and most flexible interconnect solution for PCI Express Gen3 servers used in Enterprise Data Centers, High-Performance Computing, and Embedded environments.

This chapter covers the following topics:

- [Section 1.1, “Product Overview,” on page 11](#)
- [Section 1.2, “Features and Benefits,” on page 12](#)
- [Section 1.3, “Operating Systems/Distributions,” on page 13](#)
- [Section 1.4, “Connectivity,” on page 13](#)

1.1 Product Overview

The following section provides the ordering part number, port speed, number of ports, and PCI Express speed. Each adapter comes with two bracket heights - short and tall. Single and Dual-port FDR Adapter Cards.

Table 3 - Single and Dual-port FDR Adapter Cards

Ordering Part Number (OPN)	MCX353A-FCCT - single-port card MCX354A-FCCT - dual-port card
Data Transmission Rate	InfiniBand - FDR (56 Gb/s) Ethernet - 40/56 Gb/s
Network Connector Types	single or dual-port QSFP+
PCI Express (PCIe) SerDes Speed	PCIe 3.0 x8 8GT/s
RoHS	R6
Adapter IC Part Number	MT27528A0-FCCR-FV
Device ID (decimal)	4103 for Physical Function 4100 for Virtual Function

1.2 Features and Benefits

Table 4 - Features

Virtual Protocol Interconnect (VPI)	VPI-enabled adapters facilitate any standard networking, clustering, storage, and management protocol to seamlessly operate over any converged network with the same software infrastructure.
InfiniBand Architecture Specification v1.2.1 compliant	ConnectX-3 Pro delivers low latency, high bandwidth, and computing efficiency for performance-driven server and storage clustering applications. ConnectX-3 Pro is InfiniBand Architecture Specification v1.2.1 compliant.
PCI Express (PCIe)	Uses PCIe Gen 3.0 (1.1 and 2.0 compatible) through an x8 edge connector up to 8GT/s
10/40/56 Gigabit Ethernet	Mellanox adapters comply with the following IEEE 802.3* standards: IEEE Std 802.3-2008 Ethernet IEEE Std 802.3ae 10 Gigabit Ethernet IEEE Std 802.3ba 40 Gigabit Ethernet IEEE Std 802.3ad Link Aggregation and Failover
InfiniBand FDR	A pre-standard InfiniBand data rate, where each lane of a 4X port runs a bit rate of 14.0625Gb/s with a 64b/66b encoding, resulting in an effective bandwidth of 54.54Gb/s.
InfiniBand FDR10	An InfiniBand transport and link layer running over a physical layer using the PCS encoding of 64b/66b and a bit rate of 10.3125Gb/s per lane.
InfiniBand QDR	A standard InfiniBand data rate, where each lane of a 4X port runs a bit rate of 10Gb/s with an 8b/10b encoding.
Memory	PCI Express - stores and accesses InfiniBand and/or Ethernet fabric connection information and packet data SPI - includes one 4MB SPI Flash device (M25PX16-VMN6P device by ST Microelectronics) EEPROM - accessible through the I ² C-compatible interface. The EEPROM capacity is 4Kb.
Virtualized Overlay Networks	ConnectX-3 Pro effectively addresses the increasing demand for an overlay network, enabling superior performance by introducing advanced NVGRE and VXLAN hardware offload engines that enable the traditional offloads to be performed on the encapsulated traffic. With ConnectX-3 Pro, data center operators can decouple the overlay network layer from the physical NIC performance, thus achieving native performance in the new network architecture.
RDMA over Converged Ethernet (RoCE)	Leveraging Data Center Bridging capabilities, RoCE provides efficient low latency RDMA services over Layer 2 Ethernet.
CPU offload	Adapter functionality enabling reduced CPU overhead allowing more available CPU
GPUDirect RDMA	Using GPUDirect RDMA, adapters can directly read and write CUDA host and device memory, eliminating unnecessary system memory copies and CPU overhead, resulting in significant performance improvements.

Table 4 - Features

Sockets Acceleration	Applications utilizing TCP/UDP/IP transport can achieve industry leading throughput over InfiniBand or 10/40/56GbE. The hardware-based stateless off-load engines in ConnectX-3 Pro reduce the CPU overhead of IP packet transport. Sockets acceleration software further increases performance for latency sensitive applications.
Quality of Service (QoS)	Support for port-based Quality of Service enabling various application requirements for latency and SLA
Hardware-based I/O virtualization	ConnectX-3 Pro provides dedicated adapter resources and guaranteed isolation and protection for virtual machines within the server.
SR-IOV	ConnectX-3 Pro SR-IOV technology provides dedicated adapter resources and guaranteed isolation and protection for virtual machines (VM) within the server. I/O virtualization with ConnectX-3 Pro gives data center managers better server utilization while reducing cost, power, and cable complexity.
Storage Acceleration	A consolidated compute and storage network achieves significant cost-performance advantages over multi-fabric networks. Standard block and file access protocols can leverage InfiniBand RDMA for high-performance storage access.

1.3 Operating Systems/Distributions

- Citrix XenServer 6.1
- RHEL/CentOS 5.X and 6.X, Novell SLES10 SP4;
- SLES11 SP1, SLES 11 SP2, OEL, Fedora 14,15,17, Ubuntu 12.04
- Windows Server 2008/2012
- FreeBSD
- OpenFabrics Enterprise Distribution (OFED)
- OpenFabrics Windows Distribution (WinOF)
- VMware ESXi 4.x and 5.x

1.4 Connectivity

- Interoperable with 10/40GbE switches
- Interoperable with 56GbE Mellanox switches
- Passive copper cable with ESD protection
- Powered connectors for optical and active cable support
- QSFP+ to SFP+ connectivity through QSA module
- Interoperable with 40/56 Gb/s InfiniBand
- Passive copper cable with ESD protection

2 Interfaces

Each adapter card includes the following interfaces:

- “InfiniBand Interface”
- “Ethernet Interface”
- “PCI Express Interface”
- “I2C-compatible Interface”
- “LED Interface”

Figure 1: MCX354A-FCCT Card

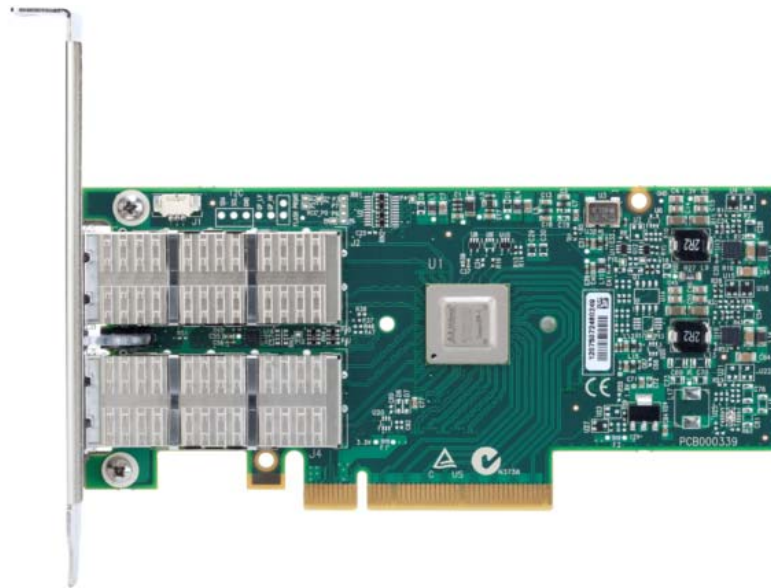

The adapter cards include special circuits to protect from ESD shocks to the card/server when plugging copper cables.

2.1 InfiniBand Interface

The network ports of the ConnectX®-3 Pro adapter cards are compliant with the *InfiniBand Architecture Specification, Release 1.2.1*. InfiniBand traffic is transmitted through the cards' QSFP+ connectors.

2.2 Ethernet Interface

The network ports of the ConnectX®-3 Pro adapter cards are compliant with the IEEE 802.3 Ethernet standards listed in [Table 4, “Features,” on page 12](#). Ethernet traffic is transmitted through the cards' QSFP+ connectors. For connecting to an SFP+ interface, you can use Mellanox QSA (QSFP to SFP+) adapter module (to be ordered separately).

2.3 PCI Express Interface

The ConnectX®-3 Pro adapter cards support PCI Express 3.0 (1.1 and 2.0 compatible) through an x8 edge connector. The device can be either a master initiating the PCI Express bus operations or a slave responding to PCI bus operations. The following lists PCIe interface features:

- PCIe Base 3.0 compliant, 1.1 and 2.0 compatible
- 2.5, 5.0, or 8.0GT/s link rate x8
- Auto-negotiates to x8, x4, x2, or x1
- Support for MSI/MSI-X mechanisms

2.4 I²C-compatible Interface

A three-pin header on the adapter cards is provided as the I²C-compatible interface. See [Figure 8, “Mechanical Drawing of the Dual-port MCX354A-FCCT Adapter Card,”](#) on page 65 for the location on the board.

2.5 LED Interface

There are two I/O LEDs per port. For LED specifications please refer to [Section 7.3, “Adapter Led Operations,”](#) on page 63.

3 Hardware Installation

3.1 System Requirements

3.1.1 Hardware

A system with a PCI Express x8 slot is required for installing the card.

3.1.2 Operating Systems/Distributions

Please refer to [Section 1.3, “Operating Systems/Distributions,”](#) on page 13.

3.1.3 Software Stacks

Mellanox OpenFabric software package MLNX_OFED for Linux, WinOF for Windows and ESX 5.1 for VMware. See [Chapter 4, “Driver Installation”](#) on page 22.

3.2 Safety Precautions



The adapter is being installed in a system that operates with voltages that can be lethal. Before opening the case of the system, observe the following precautions to avoid injury and prevent damage to system components.

1. Remove any metallic objects from your hands and wrists.
2. Make sure to use only insulated tools.
3. Verify that the system is powered off and is unplugged.
4. It is strongly recommended to use an ESD strap or other antistatic devices.

3.3 Pre-installation Checklist

1. Verify that your system meets the hardware and software requirements stated above.
2. Shut down your system if active.
3. After shutting down the system, turn off power and unplug the cord.
4. Remove the card from its package. Please note that the card must be placed on an antistatic surface.
5. Check the card for visible signs of damage. Do not attempt to install the card if damaged.

3.4 Bracket Installation Instructions

The card is usually shipped with a tall bracket installed. If this form factor is suitable for your requirements, you can skip the remainder of this section and move to [Section 3.5, “Card Installation Instructions,”](#) on page 18. If you need to replace it with the short bracket that is included in the shipping box, please follow the instructions in this section.

Note: Due to risk of damaging the EMI gasket, it is not recommended to replace the bracket more than three times.

To replace the bracket you will need the following parts:

- The new bracket of the proper height
- The 2 screws saved from the removal of the bracket
- The 2 fiber washers saved from the removal of the bracket

3.4.1 Removing the Existing Bracket

Figure 2: Bracket Screws

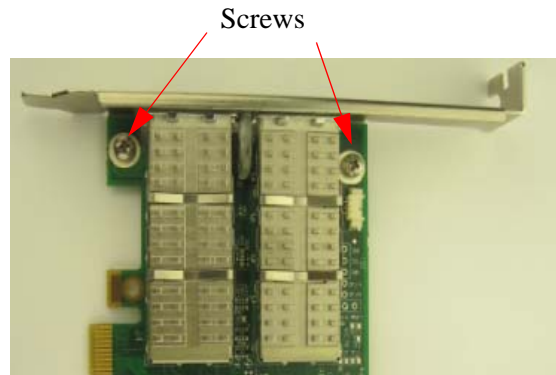

1. Remove the two screws holding the bracket in place. The bracket comes loose from the card.



Be careful not to put stress on the LEDs.

2. Save the two screws and the two fiber washers.

3.4.2 Installing the New Bracket

1. Place the bracket onto the card until the screw holes line up. Please make sure to insert the bracket until the end of the EMI fingers. See [Figure 3](#).

Figure 3: EMI Fingers (Example)

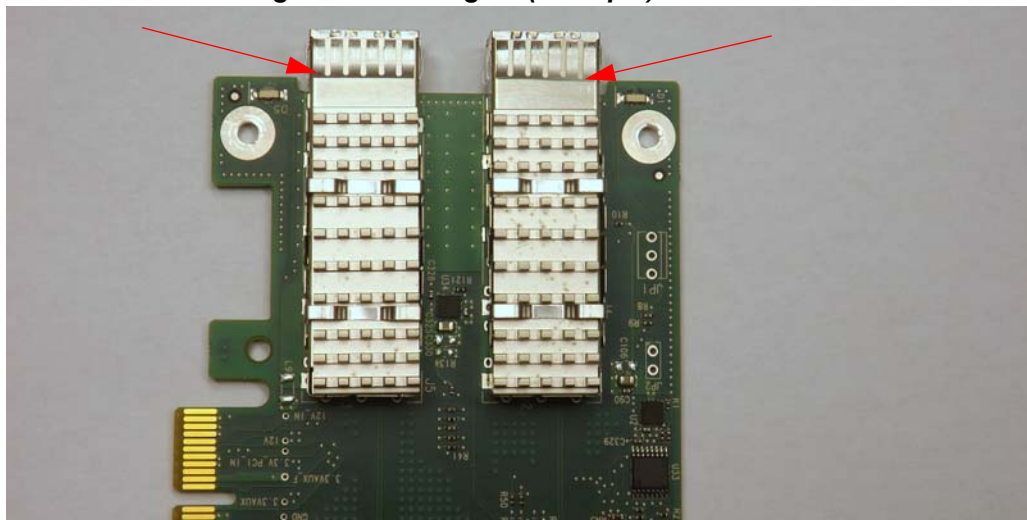



Do not force the bracket onto the card. You may have to gently push the LEDs using a small screwdriver to align the LEDs with the holes in the bracket.

2. Screw on the bracket using the screws and washers saved from the bracket removal procedure above.

Figure 4: Placing the Bracket on the Card

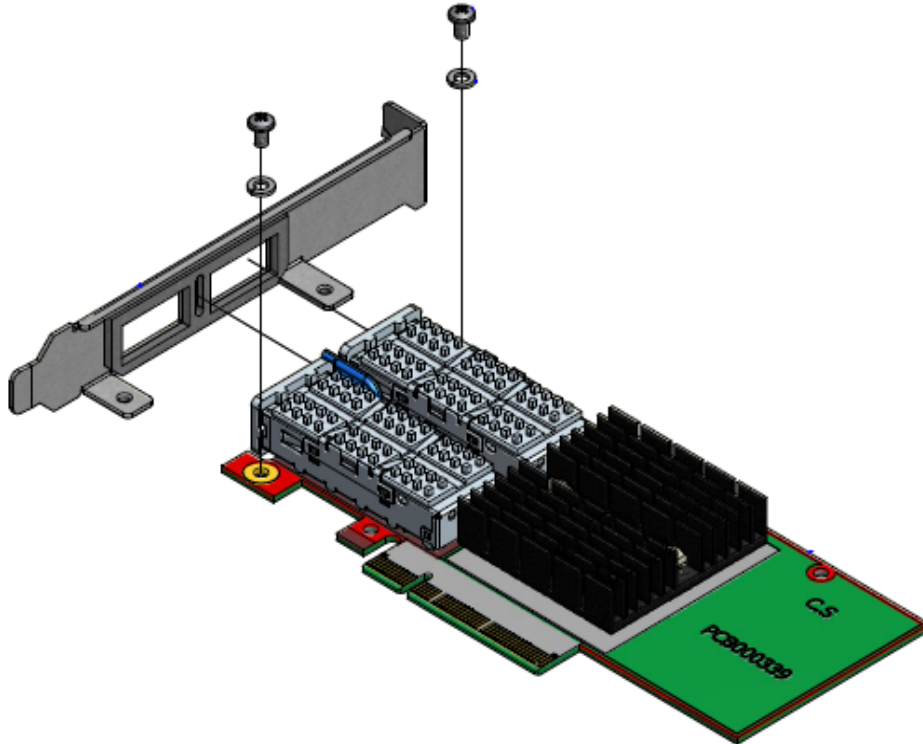

3. Make sure that the LEDs are aligned onto the bracket holes.
4. Use a torque driver to apply up to 2 lbs-in torque on the screws.

3.5 Card Installation Instructions

1. Before installing the card, make sure that the system is off and the power cord is not connected to the server. Please follow proper electrical grounding procedures.
2. Open the system case.
3. Place the adapter in an available PCI Express slot.



A lesser width adapter can be seated into a greater width slot (x4 in a x8), but a greater width adapter cannot be seated into a lesser width slot (x8 in a x4). Align the adapter connector edge with the PCI Express connector slot.

4. Applying even pressure at both corners of the card, insert the adapter card into the slot until it is firmly seated. When the adapter is properly seated, the adapter port connectors are aligned with the slot opening, and the adapter faceplate is visible against the system chassis.



Do not use excessive force when seating the card, as this may damage the system or the adapter.

5. Secure the adapter with the adapter clip or screw.
6. Close the system case.

3.6 Cables and Modules

To obtain the list of supported cables for your adapter, please refer to www.mellanox.com => Products => Cables and Transceivers.

3.6.1 Cable Installation

1. All cables can be inserted or removed with the unit powered on.
2. To insert a cable, press the connector into the port receptacle until the connector is firmly seated.
 - a. Support the weight of the cable before connecting the cable to the adapter card. Do this by using a cable holder or tying the cable to the rack.
 - b. Determine the correct orientation of the connector to the card before inserting the connector. Do not try and insert the connector upside down. This may damage the adapter card.
 - c. Insert the connector into the adapter card. Be careful to insert the connector straight into the cage. Do not apply any torque, up or down, to the connector cage in the adapter card.
 - d. Make sure that the connector locks in place.



When installing cables make sure that the latches engage.



Always install and remove cables by pushing or pulling the cable and connector in a straight line with the card.

3. After inserting a cable into a port, the Green LED indicator will light when the physical connection is established (that is, when the unit is powered on and a cable is plugged into the port with the other end of the connector plugged into a functioning port). See [Section 7.3, “Adapter Led Operations,”](#) on page 63.
4. After plugging in a cable, lock the connector using the latching mechanism particular to the cable vendor. When a logical connection is made the Yellow LED will light. When data is

being transferred the yellow led will blink. See [Section 7.3, “Adapter Led Operations,”](#) on [page 63](#).

5. Care should be taken as not to impede the air exhaust flow through the ventilation holes. Use cable lengths which allow for routing horizontally around to the side of the chassis before bending upward or downward in the rack.
6. To remove a cable, disengage the locks and slowly pull the connector away from the port receptacle. Both LED indicators will turn off when the cable is unseated.
 - a. Pull on the latch release mechanism thereby unlatching the connector and pull the connector out of the cage.
 - b. Do not apply torque to the connector when removing it from the adapter card.
 - c. Remove any cable supports that were used to support the cable’s weight.

3.7 Identify the Card in Your System

3.7.1 On Windows

1. Open Device Manager on the server. Click start => Run, and then enter “devmgmt.msc”.
2. Expand System Devices and locate your Mellanox ConnectX-3 Pro adapter card.
3. Right click the mouse on your adapter's row and select properties to display the adapter card properties window.
4. Click the Details tab and select **Device Instance Id** (Windows 2003) or **Hardware Ids** (Windows 2008/R2) from the Properties pull-down menu.

Note: [Figure 5](#) is an example using ConnectX-3 device. This figure will be updated in future releases.

Figure 5: PCI Device

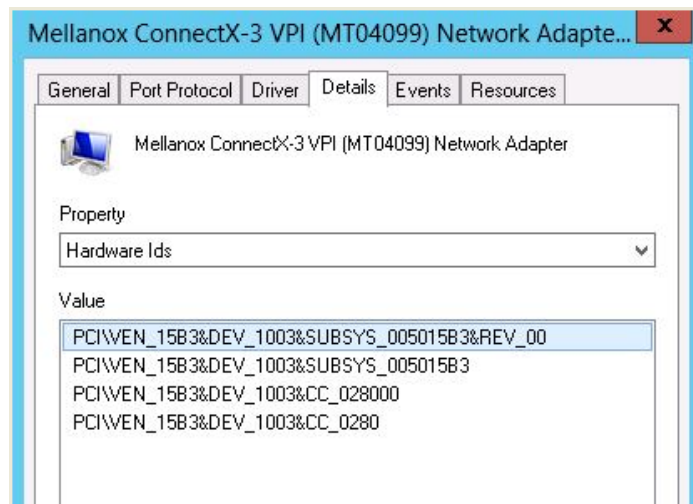

1. In the Value display box, check the fields VEN and DEV (fields are separated by '&'). In the display example above, notice the sub-string “PCI\VEN_15B3&DEV_1003”: VEN is equal to 0x15B3 – this is the Vendor ID of Mellanox Technologies; and DEV is equal to 1003 – this is a valid Mellanox Technologies PCI Device ID.



If the PCI device does not have a Mellanox adapter ID, return to Step 2 to check another device.



The list of Mellanox Technologies PCI Device IDs can be found in the PCI ID repository at <http://pci-ids.ucw.cz/read/PC/15b3>.

3.7.2 On Linux

Get the device location on the PCI bus by running `lspci` and locating lines with the string “Mellanox Technologies”:

```
> lspci |grep -i Mellanox  
27:00.0 Network controller: Mellanox Technologies MT27520 Family [ConnectX-3 Pro]
```

4 Driver Installation



The below sections are examples using ConnectX-3 device and will be updated to include ConnectX-3 Pro in future releases.

4.1 Linux Driver

For Linux, download and install the latest OpenFabrics Enterprise Distribution (OFED) software package available via the Mellanox web site at: <http://www.mellanox.com> => Products => Software => InfiniBand/VPI Drivers => Download. This chapter describes how to install and test the Mellanox OFED for Linux package on a single host machine with Mellanox ConnectX-3 Pro adapter hardware installed.

4.1.1 Hardware and Software Requirements

Table 5 - Software and Hardware Requirements

Requirements	Description
Platforms	For the list of supported architecture platforms, please refer to the Mellanox OFED Release Notes file.
Required Disk Space for Installation	1GB
Device ID	For the latest list of device IDs, please visit http://pci-ids.ucw.cz/read/PC/15b3 .
Operating System	Linux operating system. For the list of supported operating system distributions and kernels, please refer to the http://www.mellanox.com => Products => Software => InfiniBand/VPI Drivers => Mellanox OFED Release Notes file.
Installer Privileges	The installation requires administrator privileges on the target machine.

4.1.2 Downloading Mellanox OFED

Step 1. Verify that the system has a Mellanox network adapter (HCA/NIC) installed by ensuring that you can see ConnectX entries in the display.

The following example shows a system with an installed Mellanox HCA:

```
host1# lspci -v | grep Mellanox
02:00.0 InfiniBand: Mellanox Technologies MT27520 [ConnectX-3 Pro]
```

Step 2. Download the ISO image to your host.

The image's name has the format `MLNX_OFED_LINUX-<ver>-<OS label><CPU arch>.iso`. You can download it from <http://www.mellanox.com> => Products => Software => InfiniBand/VPI Drivers.

- Step 3.** Use the `md5sum` utility to confirm the file integrity of your ISO image. Run the following command and compare the result to the value provided on the download page.

```
host1# md5sumMLNX_OFED_LINUX-<ver>-<OS label>.iso
```

4.1.3 Installing Mellanox OFED

Mellanox OFED includes an installation script called `mlnxofedinstall` which performs the following:

- Discovers the currently installed kernel
- Uninstalls any software stacks that are part of the standard operating system distribution or another vendor's commercial stack
- Installs the `MLNX_OFED_LINUX` binary RPMs (if they are available for the current kernel)
- Identifies the currently installed InfiniBand and Ethernet network adapters and automatically¹ upgrades the firmware

4.1.3.1 Pre-installation Notes

- The installation script removes all previously installed Mellanox OFED packages and re-installs from scratch. You will be prompted to acknowledge the deletion of the old packages.



Pre-existing configuration files will be saved with the extension “.conf.rpmsave”.

- If you need to install Mellanox OFED on an entire (homogeneous) cluster, a common strategy is to mount the ISO image on one of the cluster nodes and then copy it to a shared file system such as NFS. To install on all the cluster nodes, use cluster-aware tools (such as `pdsh`).
- If your kernel version does not match with any of the offered pre-built RPMs, you can add your kernel version by using the “`mlnx_add_kernel_support.sh`” script located under the `docs/` directory.

Usage:

```
mlnx_add_kernel_support.sh -m|--mlnx_ofed <path to MLNX_OFED
>directory> [--make-iso|--make-tgz]
>
>[--make-iso]           Create MLNX_OFED ISO image.
>[--make-tgz]          Create MLNX_OFED tarball. (Default)
>[-t|--tmpdir <local work dir>]
>[--kmp]
>[-v|--verbose]
```

1. The firmware will not be updated if you run the install script with the ‘--without-fw-update’ option.

Example

The following command will create a MLNX_OFED_LINUX ISO image for RedHat 5.6 under the /tmp directory.

```
MLNX_OFED_LINUX-1.5.3-rhel5.6-x86_64/docs/mlnx_add_kernel_support.sh -i /mnt/MLNX-
_OFED_LINUX-1.5.3-rhel5.6-x86_64.iso
All Mellanox, OEM, OFED, or Distribution IB packages will be removed.
Do you want to continue? [y/N]:y
Removing OFED RPMs...
Running mkisofs...
Created /tmp/MLNX_OFED_LINUX-1.5.3-rhel5.6-x86_64.iso
```

4.1.3.2 Installation Script

The usage of the installation script is described below. You will use it during the installation procedure described in [Section 4.1.3.4, “Installation Procedure,”](#) on page 26.

Usage

```
./mnt/mlnxofedinstall [OPTIONS]
```

Options

-c -- config <packages config_file>	Example of the configuration file can be found under docs
-n --net <network config file>	Example of the network configuration file can be found under docs
-p --print-available	Print available packages for the current platform and create a corresponding ofed.conf file. The installation script exits after creating ofed.conf.
--without-32bit	Skip 32-bit libraries installation
--without-depcheck	Skip Distro's libraries check
--without-fw-update	Skip firmware update
--force-fw-update	Force firmware update
--force	Force installation (without querying the user)
--all	Install all kernel modules, libibverbs, libibumad, librdmacm, mft, mstflint, diagnostic tools, OpenSM, ib-bonding, MVAPICH, Open MPI, MPI tests, MPI selector, perftest, sdpnetstat and libsdp srptools, rds tools, static and dynamic libraries
--hpc	Install all kernel modules, libibverbs, libibumad, librdmacm, mft, mstflint, diagnostic tools, OpenSM, ib-bonding, MVAPICH, Open MPI, MPI tests, MPI selector, dynamic libraries
--basic	Install all kernel modules, libibverbs, libibumad, mft, mstflint, dynamic libraries
--msm	Install all kernel modules, libibverbs, libibumad, mft, mstflint, diagnostic tools, OpenSM, ib-bonding, dynamic libraries NOTE: With --msm flag, the OpenSM daemon is configured to run upon boot.
--vma	Install packages required by VMA to support both IB and Ethernet
--vma-ib	Install packages required by VMA to work over InfiniBand
--vma-eth	Install packages required by VMA to work over Ethernet
-v -vv -vvv	Set verbosity level
-q	Set quiet - no messages will be printed
--umad-dev-rw	Grant non root users read/write permission for umad devices instead of default
--hugepages-overcommit	Set 80% of MAX_MEMORY as overcommit for a huge page allocation

4.1.3.3 mlnxofedinstall Return Codes

Table 6 lists the `mlnxofedinstall` script return codes and their meanings.

Table 6 - `mlnxofedinstall` Return Codes

Return Code	Meaning
0	The Installation ended successfully
1	The installation failed
2	No firmware was found for the adapter device
22	Invalid parameter
28	Not enough free space
171	Not applicable to this system configuration. This can occur when the required hardware is not present on the system.
172	Prerequisites are not met. For example, missing the required software installed or the hardware is not configured correctly.
173	Failed to start the <code>mst</code> driver

4.1.3.4 Installation Procedure

- Step 1.** Login to the installation machine as root.
- Step 2.** Mount the ISO image on your machine

```
host1# mount -o ro,loop MLNX_OFED_LINUX-<ver>-<OS label>-<CPU arch>.iso /mnt
```

Step 3. Run the installation script.

```

./mlnxofedinstall
This program will install the MLNX_OFED_LINUX package on your machine.
Note that all other Mellanox, OEM, OFED, or Distribution IB packages will be removed.
Do you want to continue?[y/N]:y

Uninstalling the previous version of MLNX_OFED_LINUX
[root@swl014 MLNX_OFED_LINUX-2.0-2.0.0-rhel6.3-x86_64]#
[root@swl014 MLNX_OFED_LINUX-2.0-2.0.0-rhel6.3-x86_64]# ./mlnxofedinstall
This program will install the MLNX_OFED_LINUX package on your machine.
Note that all other Mellanox, OEM, OFED, or Distribution IB packages will be removed.
Do you want to continue?[y/N]:y

Uninstalling the previous version of MLNX_OFED_LINUX

Starting MLNX_OFED_LINUX-2.0-2.0.0 installation ...

Installing mlnx-ofa_kernel RPM
Preparing... #####
mlnx-ofa_kernel #####
Installing kmod-mlnx-ofa_kernel RPM
Preparing... #####
kmod-mlnx-ofa_kernel #####
Installing mlnx-ofa_kernel-devel RPM
Preparing... #####
mlnx-ofa_kernel-devel #####
Installing kernel-mft RPM
Preparing... #####
kernel-mft #####
Installing knem RPM
Preparing... #####
knem #####
Installing mpi-selector RPM
Preparing... #####
mpi-selector #####

```

```
Installing user level RPMs:
Preparing... #####
ofed-scripts #####
Preparing... #####
libibverbs #####
Preparing... #####
libibverbs #####
Preparing... #####
libibverbs-devel #####
Preparing... #####
libibverbs-devel #####
Preparing... #####
libibverbs-devel-static #####
Preparing... #####
libibverbs-devel-static #####
Preparing... #####
libibverbs-utils #####
Preparing... #####
libmverbs #####
Preparing... #####
libmverbs #####
Preparing... #####
libmlx4 #####
Preparing... #####
libmlx4 #####
Preparing... #####
libmlx4-devel #####
Preparing... #####
libmlx4-devel #####
Preparing... #####
libmlx5 #####
Preparing... #####
libmlx5 #####
Preparing... #####
libmlx5-devel #####
Preparing... #####
libmlx5-devel #####
Preparing... #####
libmverbs-devel #####
Preparing... #####
libmverbs-devel #####
Preparing... #####
libmqe #####
Preparing... #####
libmqe #####
Preparing... #####
libmqe-devel #####
Preparing... #####
libmqe-devel #####
Preparing... #####
libibcm #####
Preparing... #####
libibcm #####
```

```
Preparing... #####
libibcm-devel #####
Preparing... #####
libibcm-devel #####
Preparing... #####
libibumad #####
Preparing... #####
libibumad #####
Preparing... #####
libibumad-devel #####
Preparing... #####
libibumad-devel #####
Preparing... #####
libibumad-static #####
Preparing... #####
libibumad-static #####
Preparing... #####
libibmad #####
Preparing... #####
libibmad #####
Preparing... #####
libibmad-devel #####
Preparing... #####
libibmad-devel #####
Preparing... #####
libibmad-static #####
Preparing... #####
libibmad-static #####
Preparing... #####
ibsim #####
Preparing... #####
ibacm #####
Preparing... #####
librdmacm #####
Preparing... #####
librdmacm #####
Preparing... #####
librdmacm-utils #####
Preparing... #####
librdmacm-devel #####
Preparing... #####
librdmacm-devel #####
Preparing... #####
opensm-libs #####
Preparing... #####
opensm-libs #####
Preparing... #####
opensm #####
```

```
Preparing... #####
opensm-devel #####
Preparing... #####
opensm-devel #####
Preparing... #####
opensm-static #####
Preparing... #####
opensm-static #####
Preparing... #####
compat-dapl #####
Preparing... #####
compat-dapl #####
Preparing... #####
compat-dapl-devel #####
Preparing... #####
compat-dapl-devel #####
Preparing... #####
dapl #####
Preparing... #####
dapl #####
Preparing... #####
dapl-devel #####
Preparing... #####
dapl-devel #####
Preparing... #####
dapl-devel-static #####
Preparing... #####
dapl-devel-static #####
Preparing... #####
dapl-utils #####
Preparing... #####
perftest #####
Preparing... #####
mstflint #####
Preparing... #####
mft #####
Preparing... #####
srptools #####
Preparing... #####
rds-tools #####
Preparing... #####
rds-devel #####
Preparing... #####
ibutils2 #####
Preparing... #####
ibutils #####
```

```

Preparing... #####
cc_mgr #####
Preparing... #####
dump_pr #####
Preparing... #####
ar_mgr #####
Preparing... #####
ibdump #####
Preparing... #####
infiniband-diags #####
Preparing... #####
qperf #####
Preparing... #####
fca #####
INFO: updating ...

IMPORTANT NOTE:
=====

- The FCA Manager and FCA MPI Runtime library are installed in /opt/mellanox/fca
directory.
- The FCA Manager will not be started automatically.
- To start FCA Manager now, type:
  /etc/init.d/fca_managerd start

- There should be single process of FCA Manager running per fabric.

- To start FCA Manager automatically after boot, type:
  /etc/init.d/fca_managerd install_service

- Check /opt/mellanox/fca/share/doc/fca/README.txt for quick start instructions.
Preparing... #####
mxm #####
Preparing... #####
openshmem #####
Preparing... #####
bupc #####
Preparing... #####
mvapich2_gcc #####
Preparing... #####
openmpi_gcc #####
Preparing... #####
mpitests_mvapich2_gcc #####
Preparing... #####
mpitests_openmpi_gcc #####
Preparing... #####
mlnxofed-docs #####

```

```

Device (05:00.0):
    05:00.0 Ethernet controller: Mellanox Technologies MT26448 [ConnectX EN
10GigE, PCIe 2.0 5GT/s] (rev b0)
    Link Width is not 8x
    PCI Link Speed: 5Gb/s

Device (07:00.0):
    07:00.0 Ethernet controller: Mellanox Technologies MT27500 Family [ConnectX-3]
    Link Width: 8x
    PCI Link Speed: 5Gb/s

Installation finished successfully.

The firmware version on /dev/mst/mt26448_pci_cr0 - 2.9.1000 is up to date.
Note: To force firmware update use '--force-fw-update' flag.
The firmware version on /dev/mst/mt4099_pci_cr0 - 2.11.500 is up to date.
Note: To force firmware update use '--force-fw-update' flag.

```



In case your machine has the latest firmware, no firmware update will occur and the installation script will print at the end of installation a message similar to the following:

```

...
The firmware version on /dev/mst/mt26448_pci_cr0 - 2.9.1000 is up
to date.
Note: To force firmware update use '--force-fw-update' flag.
The firmware version on /dev/mst/mt4099_pci_cr0 - 2.11.500 is up
to date.
Note: To force firmware update use '--force-fw-update' flag.

```



In case your machine has an unsupported network adapter device, no firmware update will occur and the error message below will be printed. Please contact your hardware vendor for help on firmware updates.

```

Error message:
-I- Querying device ...
-E- Can't auto detect fw configuration file: ...

```

- Step 4.** In case the installation script performed firmware updates to your network adapter hardware, it will ask you to reboot your machine.
- Step 5.** The script adds the following lines to `/etc/security/limits.conf` for the userspace components such as MPI:

```

* soft memlock unlimited
* hard memlock unlimited

```

These settings unlimit the amount of memory that can be pinned by a user space application. If desired, tune the value unlimited to a specific amount of RAM.

- Step 6.** For your machine to be part of the InfiniBand/VPI fabric, a Subnet Manager must be running on one of the fabric nodes. At this point, Mellanox OFED for Linux has already installed the OpenSM Subnet Manager on your machine. For details on starting OpenSM, refer to the OFED User Manual. See [Table 2, “Documents List,” on page 9](#).
- Step 7.** (InfiniBand only) Run the `hca_self_test.ofed` utility to verify whether or not the InfiniBand link is up. The utility also checks for and displays additional information such as
- HCA firmware version
 - Kernel architecture

- Driver version
- Number of active HCA ports along with their states
- Node GUID

Note: For more details on `hca_self_test.ofed`, see the file `hca_self_test.readme` under `docs/`.

```
# hca_self_test.ofed

---- Performing Adapter Device Self Test ----
Number of CAs Detected ..... 2
PCI Device Check ..... PASS
Kernel Arch ..... x86_64
Host Driver Version ..... MLNX_OFED_LINUX-2.0-2.0.0 (OFED-2.0-2.0.0):
2.6.32-279.el6.x86_64
Host Driver RPM Check ..... PASS
Firmware on CA #0 NIC ..... v2.9.1000
Firmware Check on CA #0 (NIC) ..... PASS
Firmware on CA #1 NIC ..... v2.11.500
Firmware Check on CA #1 (NIC) ..... PASS
Host Driver Initialization ..... PASS
Number of CA Ports Active ..... 4
Port State of Port #1 on CA #0 (NIC).... UP 1X QDR (Ethernet)
Port State of Port #2 on CA #0 (NIC).... UP 1X QDR (Ethernet)
Port State of Port #1 on CA #1 (NIC).... UP 1X QDR (Ethernet)
Port State of Port #2 on CA #1 (NIC).... UP 1X QDR (Ethernet)
Error Counter Check on CA #0 (NIC).... NA (Eth ports)
Error Counter Check on CA #1 (NIC).... NA (Eth ports)
Kernel Syslog Check ..... PASS
Node GUID on CA #0 (NIC) ..... 00:02:c9:03:00:07:4f:f8
Node GUID on CA #1 (NIC) ..... 00:02:c9:03:00:35:fd:c0
----- DONE -----
```



After the installer completes, information about the Mellanox OFED installation such as prefix, kernel version, and installation parameters can be retrieved by running the command `/etc/infiniband/info`.

4.1.4 Installation Results

Software

- The OFED and MFT packages are installed under the `/usr` directory.
- The kernel modules are installed under:
 - InfiniBand subsystem:

```
/lib/modules/`uname -r`/updates/kernel/drivers/infiniband/
```

- `mlx4_core` driver:

```
/lib/modules/<kernel_version>/extra/mlnx-ofa_kernel/drivers/net/ethernet/mellanox/
mlx4/mlx4_core.ko
```

- **mlx4_ib driver:**

```
/lib/modules/<kernel_version>/extra/mlnx-ofa_kernel/drivers/infiniband/hw/mlx4/mlx-4_ib.ko
```

- **mlx5_core driver:**

```
/lib/modules/<kernel_version>/extra/mlnx-ofa_kernel/drivers/net/ethernet/mellanox/mlx5/core/mlx5_core.ko
```

- **mlx5_ib driver:**

```
/lib/modules/<kernel_version>/extra/mlnx-ofa_kernel/drivers/infiniband/hw/mlx5/mlx-5_ib.ko
```

- **IPoIB:**

```
/lib/modules/`uname -r`/updates/kernel/drivers/infiniband/ulp/ipoib/ib_ipoib.ko
```

- **iSER:**

```
/lib/modules/`uname -r`/updates/kernel/drivers/infiniband/ulp/iser/ib_iser.ko
```

- **eIPoIB:**

```
/lib/modules/`uname -r`/updates/kernel/drivers/net/eipoib/eth_ipoib.ko
```

- **SRP**

```
/lib/modules/`uname -r`/updates/kernel/drivers/infiniband/ulp/srp/ib_srp.ko
```

- **RDS:**

```
/lib/modules/`uname -r`/updates/kernel/net/rds/rds.ko
/lib/modules/`uname -r`/updates/kernel/net/rds/rds_rdma.ko
/lib/modules/`uname -r`/updates/kernel/net/rds/rds_tcp.ko
```



Kernel's modules location may vary depending on the kernel's configuration.

For example: `/lib/modules/`uname -r`/extra/kernel/drivers/net/ethernet/mellanox/mlx4/mlx4_core`

- The package `kernel-ib-devel` include files are placed under `/usr/src/ofa_kernel/include/`. These include files should be used when building kernel modules that use the stack. (Note that the include files, if needed, are “backported” to your kernel.)
- The raw package (un-backported) source files are placed under `/usr/src/ofa_kernel-<ver>`
- The script `openibd` is installed under `/etc/init.d/`. This script can be used to load and unload the software stack.
- The script `connectx_port_config` is installed under `/sbin`. This script can be used to configure the ports of ConnectX network adapter cards to Ethernet and/or InfiniBand. For details on this script, please see [Section 4.1.8, “Port Type Management on Linux”](#).
- The directory `/etc/infiniband` is created with the files `info` and `openib.conf` and `connectx.conf`. The `info` script can be used to retrieve Mellanox OFED installation information. The `openib.conf` file contains the list of modules that are loaded when the `openibd` script is used. The `connectx.conf` file saves the ConnectX adapter card's ports configuration to Ethernet and/or InfiniBand. This file is used at driver start/restart (`/etc/init.d/openibd start`)
- The file `90-ib.rules` is installed under `/etc/udev/rules.d/`

- If OpenSM is installed, the daemon `opensmd` is installed under `/etc/init.d/` and `opensm.conf` is installed under `/etc`.
- If IPoIB configuration files are included, `ifcfg-ib<n>` files will be installed under:
 - `/etc/sysconfig/network-scripts/` on a RedHat machine
- The installation process unlimits the amount of memory that can be pinned by a user space application. See [Step 5](#).
- Man pages will be installed under `/usr/share/man/`

Firmware

- The firmware of existing network adapter devices will be updated if the following two conditions are fulfilled:
 1. You run the installation script in default mode; that is, *without* the option ‘`--without-fw-update`’.
 2. The firmware version of the adapter device is older than the firmware version included with the Mellanox OFED ISO image.



If an adapter’s Flash was originally programmed with an Expansion ROM image, the automatic firmware update will also burn an Expansion ROM image.

- In case your machine has an unsupported network adapter device, no firmware update will occur and the error message below will be printed. Please contact your hardware vendor for help on firmware updates.

Error message:

```
-I- Querying device ...
-E- Can't auto detect fw configuration file: ...
```

4.1.5 Post-installation Notes

- Most of the Mellanox OFED components can be configured or reconfigured after the installation by modifying the relevant configuration files. See the relevant chapters in this manual for details.
- The list of the modules that will be loaded automatically upon boot can be found in the `/etc/infiniband/openib.conf` file.

4.1.6 Updating Firmware After Installation

In case you ran the `mlnxofedinstall` script with the ‘`--without-fw-update`’ option and now you wish to (manually) update firmware on your adapter card(s), you need to perform the following steps:



If you need to burn an Expansion ROM image, please refer to OFED User Manual. [See Table 2, “Documents List,” on page 9.](#)



The following steps are also appropriate in case you wish to burn newer firmware that you have downloaded from Mellanox Technologies' Web site (<http://www.mellanox.com> => Support => Firmware Download).

Step 1. Start mst.

```
host1# mst start
```

Step 2. Identify your target InfiniBand device for firmware update.

1. Get the list of InfiniBand device names on your machine.

```
host1# mst status
MST modules:
-----
MST PCI module loaded
MST PCI configuration module loaded
MST Calibre (I2C) module is not loaded

MST devices:
-----
/dev/mst/mt25418_pciconf0      - PCI configuration cycles access.
                               bus:dev.fn=02:00.0 addr.reg=88
                               data.reg=92
                               Chip revision is: A0
/dev/mst/mt25418_pci_cr0      - PCI direct access.
                               bus:dev.fn=02:00.0 bar=0xdef00000
                               size=0x100000
                               Chip revision is: A0
/dev/mst/mt25418_pci_msix0    - PCI direct access.
                               bus:dev.fn=02:00.0 bar=0xdeefe000
                               size=0x2000
/dev/mst/mt25418_pci_uar0     - PCI direct access.
                               bus:dev.fn=02:00.0 bar=0xdc800000
                               size=0x800000
```

2. Your InfiniBand device is the one with the postfix “_pci_cr0”. In the example listed above, this will be /dev/mst/mt25418_pci_cr0.

Step 3. Burn firmware.

- 1.** Burning a firmware binary image using `mstflint` (that is already installed on your machine). Please refer to `MSTFLINT_README.txt` under `docs/`.
- 2.** Burning a firmware image from a `.mlx` file using the `mlxburn` utility (that is already installed on your machine).

The following command burns firmware onto the ConnectX device with the device name obtained in the example of Step 2.

```
host1$ mlxburn -dev /dev/mst/mt25418_pci_cr0 -fw /mnt/firmware/fw-25408/fw-25408-rel.mlx
```

Step 4. Reboot your machine after the firmware burning is completed.

4.1.7 Uninstalling Mellanox OFED

Use the script `/usr/sbin/ofed_uninstall.sh` to uninstall the Mellanox OFED package. The script is part of the `ofed-scripts` RPM.

4.1.8 Port Type Management on Linux

ConnectX ports can be individually configured to work as InfiniBand or Ethernet ports. By default both ConnectX ports are initialized as InfiniBand ports. If you wish to change the port type use the `connectx_port_config` script after the driver is loaded.

Running `"/sbin/connectx_port_config -s"` will show current port configuration for all ConnectX devices.

Port configuration is saved in the file: `/etc/infiniband/connectx.conf`. This saved configuration is restored at driver restart only if restarting via `"/etc/init.d/openibd restart"`.

Possible port types are:

- `eth` – Ethernet
- `ib` – Infiniband
- `auto` – Link sensing mode - Detect port type based on the attached network type. If no link is detected, the driver retries link sensing every few seconds.

Table 7 lists the ConnectX port configurations supported by VPI.

Table 7 - Supported ConnectX Port Configurations

Port 1 Configuration	Port 2 Configuration
ib	ib
ib	eth
eth	eth

Note that the configuration *Port1 = eth* and *Port2 = ib* is **not** supported.

The port link type can be configured for each device in the system at run time using the `"/sbin/connectx_port_config"` script. This utility will prompt for the PCI device to be modified (if there is only one it will be selected automatically).

In the next stage the user will be prompted for the desired mode for each port. The desired port configuration will then be set for the selected device.

This utility also has a non-interactive mode:

```
/sbin/connectx_port_config [[-d|--device <PCI device ID>] -c|--conf <port1,port2>]"
```

4.1.9 Auto Sensing

Auto Sensing enables the NIC to automatically sense the link type (InfiniBand or Ethernet) based on the link partner and load the appropriate driver stack (InfiniBand or Ethernet).

For example, if the first port is connected to an InfiniBand switch and the second to Ethernet switch, the NIC will automatically load the first switch as InfiniBand and the second as Ethernet.

4.1.9.1 Enabling Auto Sensing

Upon driver start up:

1. Sense the adapter card's port type:

If a valid cable or module is connected (QSFP, SFP+, or SFP with EEPROM in the cable/module):

- Set the port type to the sensed link type (IB/Ethernet)

Otherwise:

- Set the port type as default (Ethernet)

During driver run time:

- Sense a link every 3 seconds if no link is sensed/detected

If sensed, set the port type as sensed

4.2 Windows Driver

For Windows, download and install the latest Mellanox WinOF VPI for Windows software package available via the Mellanox web site at: <http://www.mellanox.com> Download this package from the Mellanox web site at: <http://www.mellanox.com> => Products => Software => InfiniBand/VPI Drivers => Windows SW/Driver => Download. Follow the installation instructions included in the download package (also available from the download page).

Hardware and Software Requirements

Table 8 - Software and Hardware Requirements

Requirements	Description
Required Disk Space for Installation	100 MB
Operating Systems	Windows Server 2012 (64 bit only)
Installer Privileges	The installation requires administrator privileges on the target machine.

4.2.1 Downloading MLNX_WinOF

Follow these steps to download the .exe according to your Operating System.

Step 1. Verify the machine architecture.

1. Open a CMD console (Click start-->Run and enter CMD).
2. Enter the following command:

```
> echo %PROCESSOR_ARCHITECTURE%
```

On an x64 (64-bit) machine, the output will be "AMD64".

- #### Step 2. Go to the MLNX_WinOF for Windows Web page at <http://www.mellanox.com> => Products => Software => InfiniBand/VPI Drivers => Windows SW/Drivers.

- Step 3.** Download the .exe image according to the architecture of your machine (see Step 1.). The name of the .exe is in the following format MLNX_VPI_WinOF-<version>_All_<OS>_<arch>.exe.



Installing the incorrect .exe file is prohibited. If you do so, an error message will be displayed.

For example, if you try to install a 64-bit .exe on a 32-bit machine, the wizard will display the following (or a similar) error message:



4.2.2 Extracting Files Without Running Installation

To extract the files without running installation, perform the following steps.

- Step 1.** Open a CMD console (Click Start-->Run and enter CMD).
Step 2. Enter the following command:

```
MLNX_VPI_WinOF-<version>_All_<OS>_<arch>.exe /a
```

- Step 3.** Click Next to create a server image.



Step 4. Click Change and specify the location in which the files are extracted to.

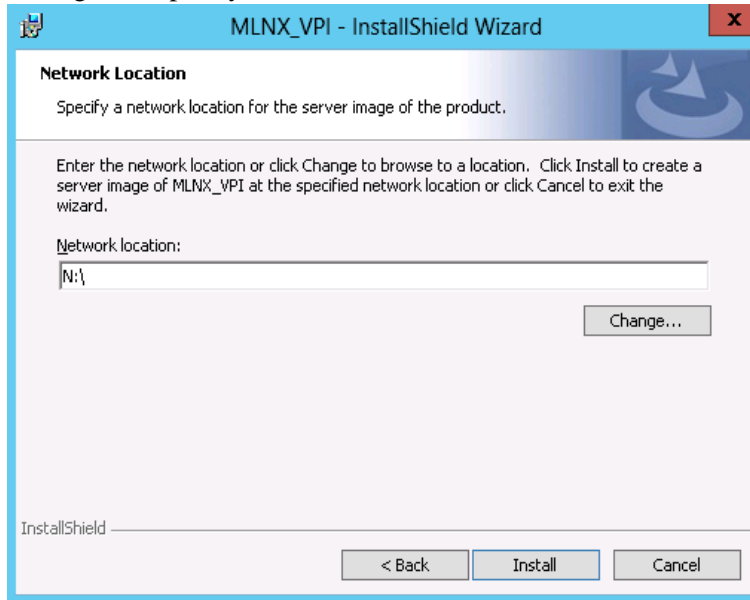

Step 5. Click Install to extract this folder, or click Change to install to a different folder.

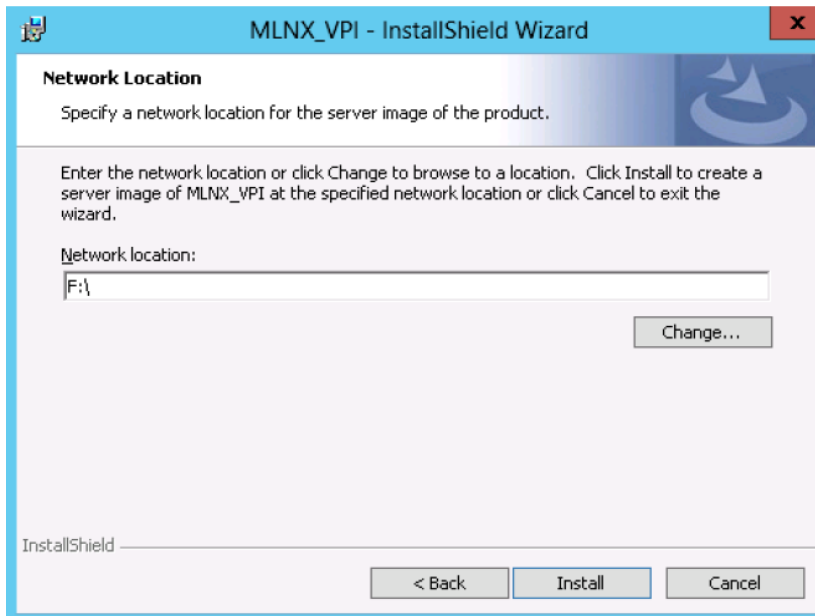

Step 6. To complete the extraction, click Finish.

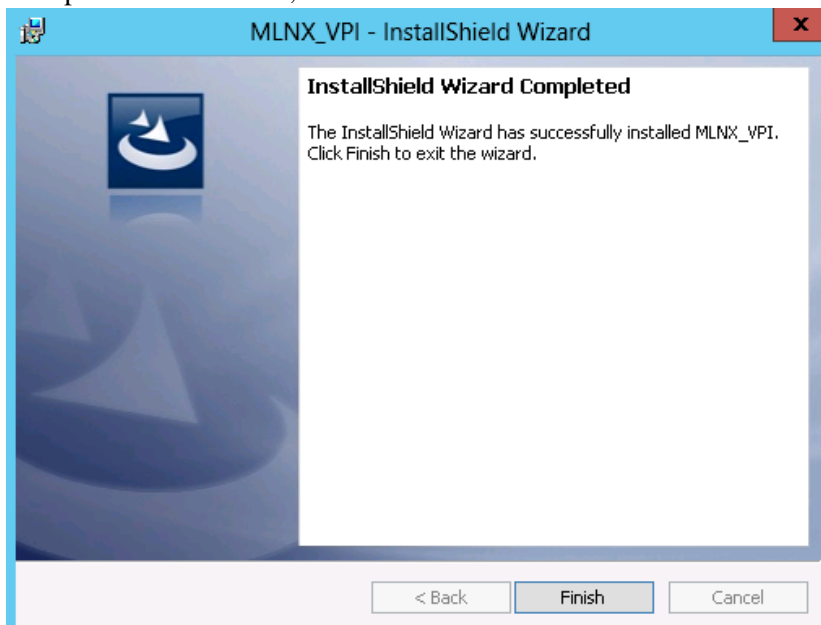

4.2.3 Installing MLNX_WinOF

This section provides instructions for two types of installation procedures:

- “Attended Installation”

An installation procedure that requires frequent user intervention.

- “Unattended Installation”

An automated installation procedure that requires no user intervention.



Both Attended and Unattended installations require administrator privileges.

4.2.3.1 Attended Installation

The following is an example of a MLNX_WinOF_win8 x64 installation session.

Step 1. Double click the .exe and follow the GUI instructions to install MLNX_WinOF.

To configure your setup to contain the logs option, please run the following command after opening a CMD console:

```
MLNX_VPI_WinOF-4_40_0_All_win8_x64.exe /v"/l*vx [LogFile]"
```

If you do not want to upgrade your firmware version, run the following command:

```
MLNX_VPI_WinOF-4_40_0_All_win8_x64.exe /v" MT_SKIPFWUPGRD=1"
```

For further help, please run:

```
MLNX_VPI_WinOF-4_40_0_All_win8_x64.exe /v" /h"
```

Click Next in the Welcome screen.

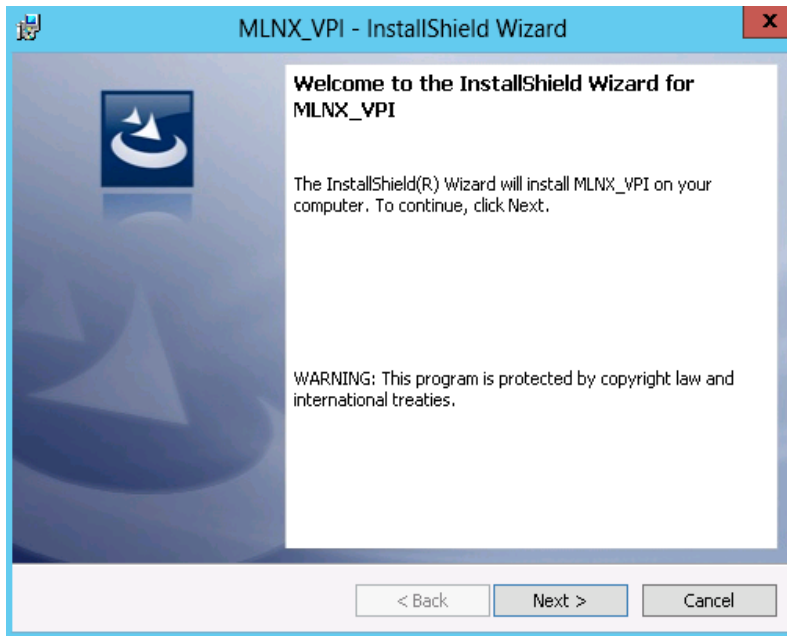

Step 2. Read then accept the license agreement and click Next.

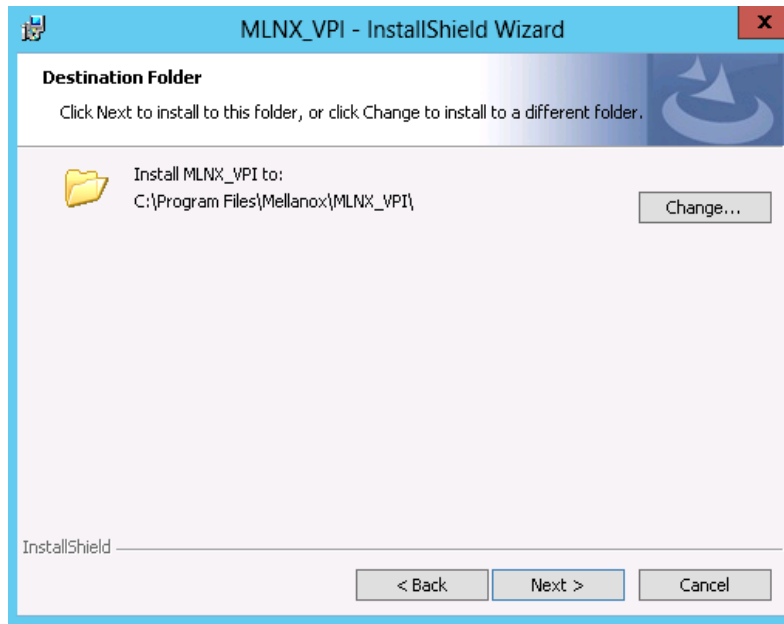

Step 3. Select the target folder for the installation.**Step 4.** The firmware upgrade screen will be displayed in the following cases:

- If the user has an OEM card, in this case the firmware will not be updated.
- If the user has a standard Mellanox card, and the firmware version is older than the one specified in WinOF Installation Guide 4.40, the firmware will be updated accordingly. However, if the user has both OEM card and Mellanox card, only Mellanox card will be updated.

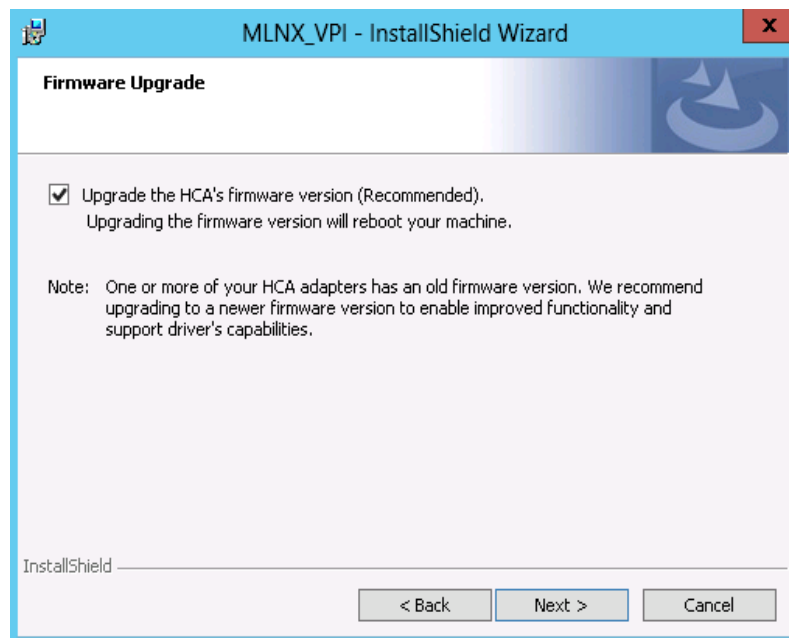

- Step 5.** Configure your system for maximum performance by checking the maximum performance box.

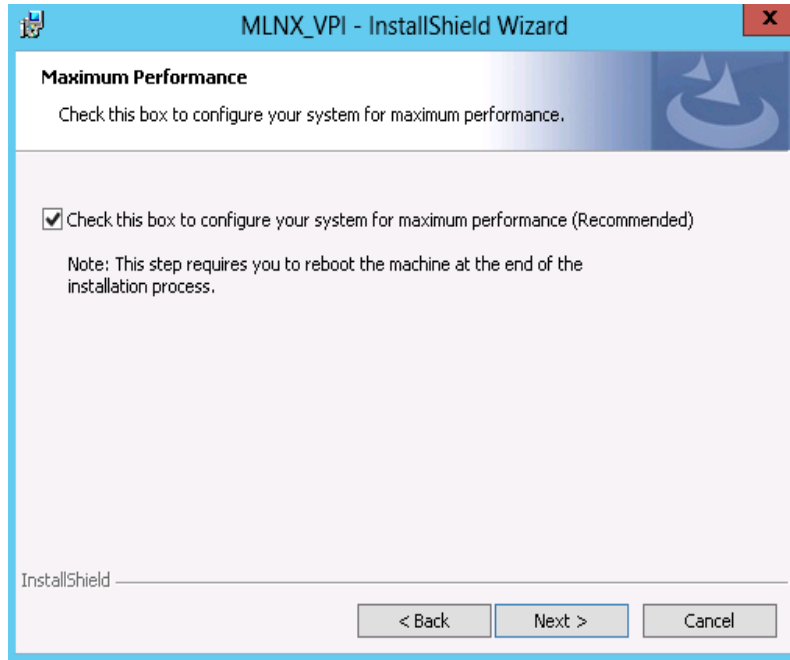

This step requires rebooting your machine at the end of the installation.

- Step 6.** Select a Complete or Custom installation, follow Step a on page 45.



- a. Select the desired feature to install:
- OpenSM - installs Windows OpenSM that is required to manage the subnet from a host. OpenSM is part of the driver and installed automatically.
 - Performance tools - install the performance tools that are used to measure the InfiniBand performance in user environment.
 - Analyze tools - install the tools that can be used either to diagnose or analyze the InfiniBand environment.
 - SDK - contains the libraries and DLLs for developing InfiniBand application over IBAL.
 - Documentation: contains the User Manual and Installation Guide.
 - ND FLTR DLLs: contains the files for standalone installation of the mlx4nd provider.

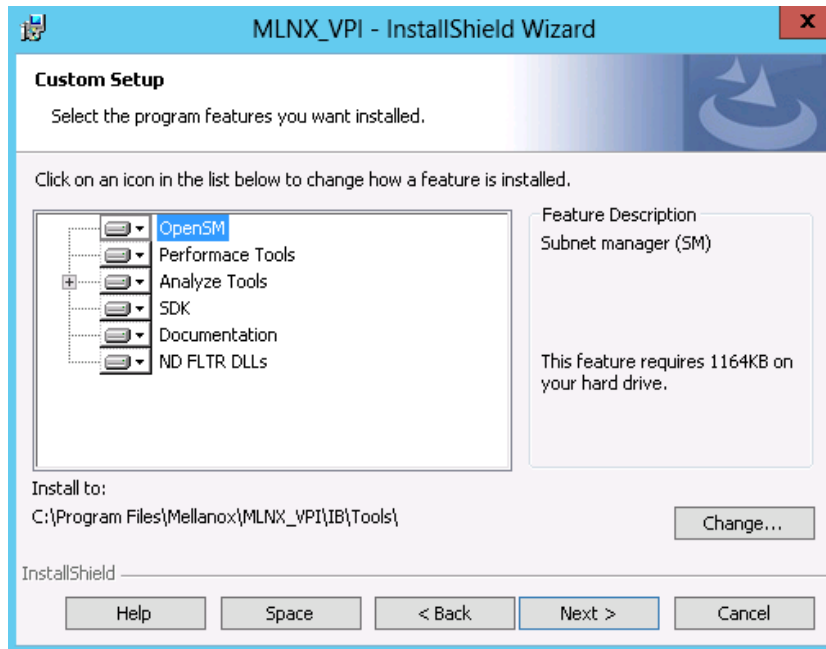

Click **Install** to start the installation.

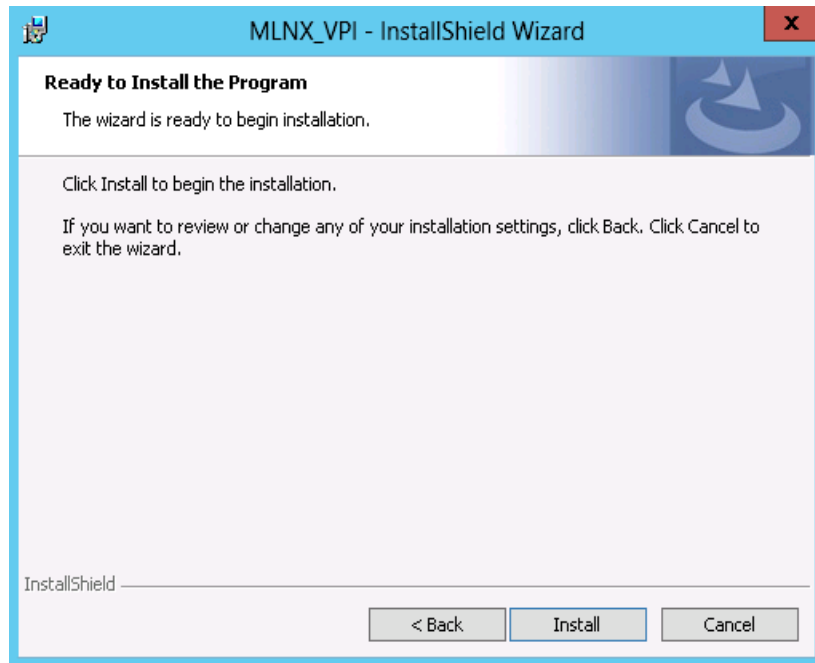

Step 7. Click **Finish** to complete the installation.

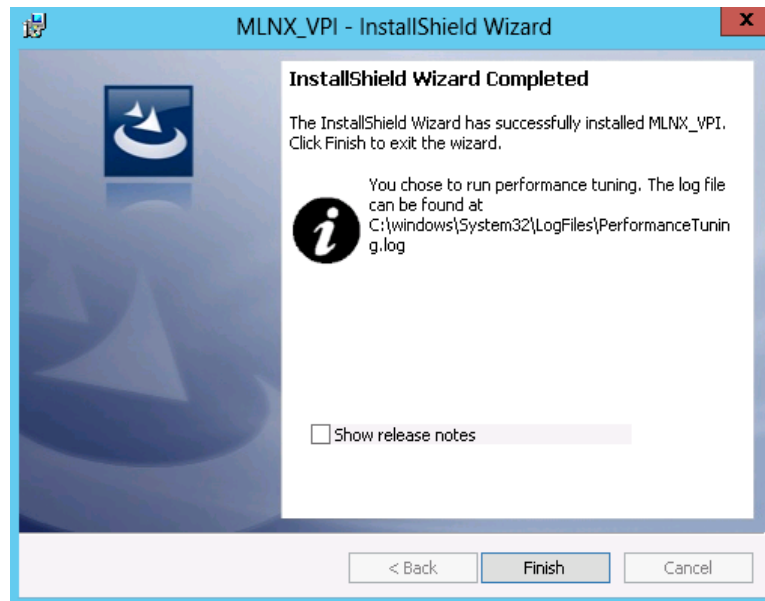

If the firmware upgrade fails, the following message will be displayed.



4.2.3.2 Unattended Installation

The following is an example of a MLNX_WinOF_win8 x64 unattended installation session.

Step 1. Open the CMD console (click Start > Run and enter 'cmd')

Step 2. Install the driver. Run:

```
> MLNX_VPI_WinOF-4_40_0_All_win8_x64.exe /S /v"/qn"
```

Step 3. [Optional] To configure your setup to contain the logs option, please run the following command:

```
> MLNX_VPI_WinOF-4_40_0_All_win8_x64.exe /S /v"/qn" /v"/l*vx [LogFile]"
```

Step 4. [Optional] If you do not want to upgrade your firmware version, run the following command:

```
> MLNX_VPI_WinOF-4_40_0_All_win8_x64.exe /S /v"/qn" /v" MT_SKIPFWUPGRD=1"
```

For further help, please run:

```
> MLNX_VPI_WinOF-4_40_0_All_win8_x64.exe /v" /h"
```

4.2.4 Upgrading MLNX_WinOF

The MLNX_WinOF driver upgrades automatically MLNX_WinOF Windows 2008R2 driver by uninstalling the previous version and installs the new driver. However, MLNX_WinOF driver upgrade in Windows 2012 driver do not completely uninstall the previous version.

- In Windows 2012 (MLNX_WinOF Rev. 4.2 and above), the network configuration is saved upon driver upgrade.
- In Windows 2008 R2 the existing configuration files are not saved upon driver upgrade.

4.2.5 Installation Results

Upon installation completion, you can verify the successful addition of the network card(s) through the Device Manager. To see the Mellanox network adapter device, and the Ethernet or IPoIB network device (depending on the used card) for each port, display the Device Manager and expand “System devices” or “Network adapters”.

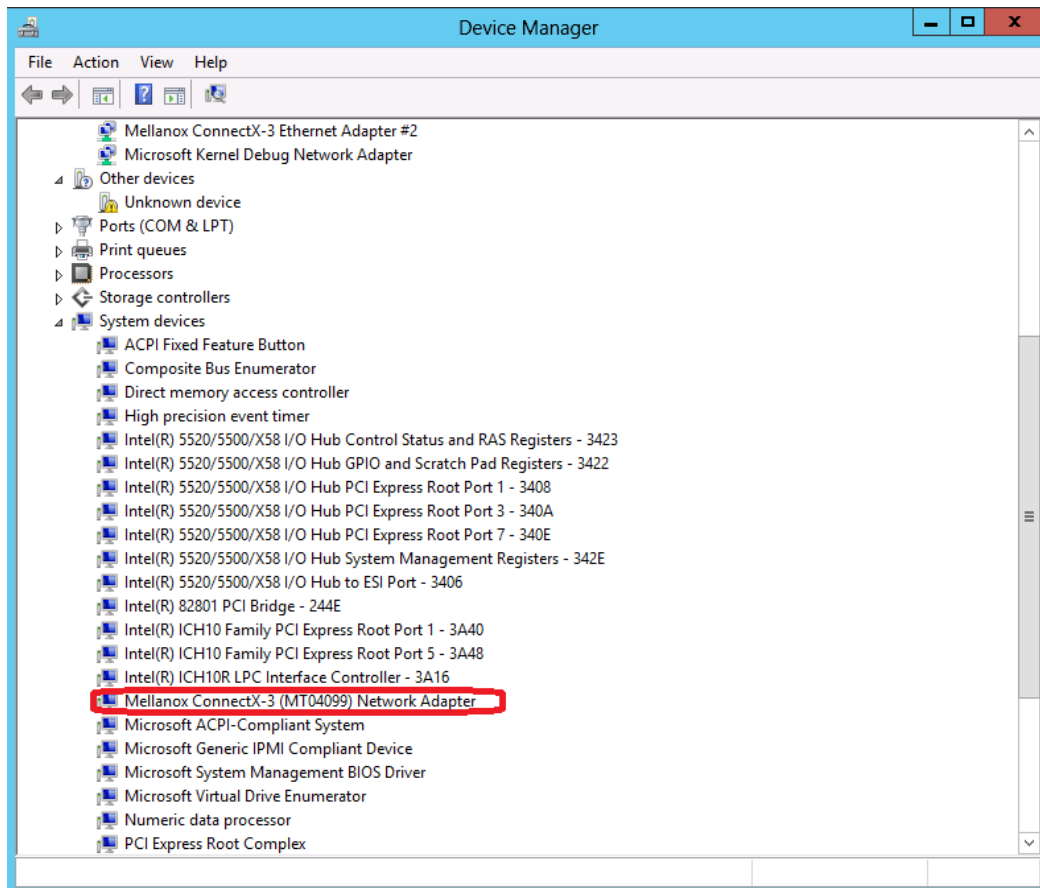

4.2.6 OpenSM Activation

OpenSM is a service required by managed networks in InfiniBand environments, and must be activated in one of the machines running on the subnet, otherwise the interface link will not come up. If the cards are connected to a managed network, there is no need to run OpenSM. Only one OpenSM should run per subnet.

In Ethernet interfaces, running OpenSM is not required.

OpenSM does not run as a service during installation as it requires the GUID parameter to decide on which port to work. Setting OpenSM upon setup results in it working only for the first port and not for the others.

➤ **To run OpenSM as a service, assuming the package was installed in the default path, use:**

```
sc create OpenSM1 binPath= "c:\Program Files\Mellanox\MLNX_VPI\IB\Tools\
opensm.exe --service" start=auto"
```

➤ **To start the service, run:**

```
sc start opensm
```

For further information, please refer to the “OpenSM - Subnet Manager” chapter in the User Manual.

4.2.7 Uninstalling MLNX_WinOF

4.2.7.1 Attended Uninstall

➤ *To uninstall MLNX_WinOF on a single node, perform one of the following options:*

1. Click Start => Control Panel => Programs and Features => MLNX_VPI => Uninstall. (NOTE: This requires elevated administrator privileges.)
2. Double click the .exe and follow the instructions of the install wizard.
3. Click Start => All Programs => Mellanox Technologies => MLNX_WinOF => Uninstall MLNX_WinOF.

4.2.7.2 Unattended Uninstall

➤ *To uninstall MLNX_WinOF in unattended mode, perform the following:*

Step 1. Open a CMD console.

Step 2. Uninstall the driver. Run:

```
MLNX_VPI_WinOF-4_40_0_All_win8_x64.exe /S /x /v"/qn"
```

4.2.8 Assigning Port IP After Installation

By default, your machine is configured to obtain an automatic IP address via a DHCP server. In some cases, the DHCP server may require the MAC address of the network adapter installed in your machine.

➤ *To obtain the MAC address:*

Step 1. Open a CMD console

Step 2. Display the MAC address as “Physical Address”

```
ipconfig /all
```

Configuring a static IP is the same for both IPoIB and Ethernet adapters.

➤ *To assign a static IP address to a network port after installation:*

Step 1. Open the Network Connections window. Locate Local Area Connections with Mellanox devices.

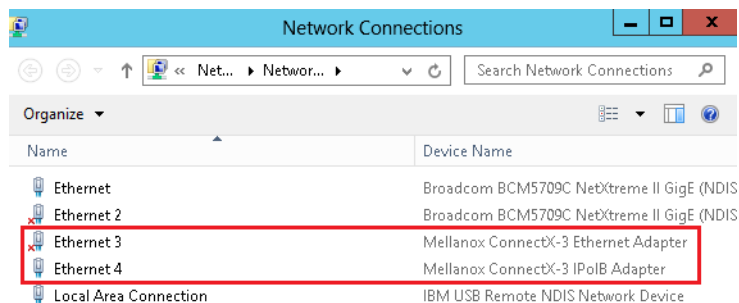

Step 2. Right-click a Mellanox Local Area Connection and left-click Properties.



Step 3. Select Internet Protocol Version 4 (TCP/IPv4) from the scroll list and click Properties.

Step 4. Select the “Use the following IP address:” radio button and enter the desired IP information.

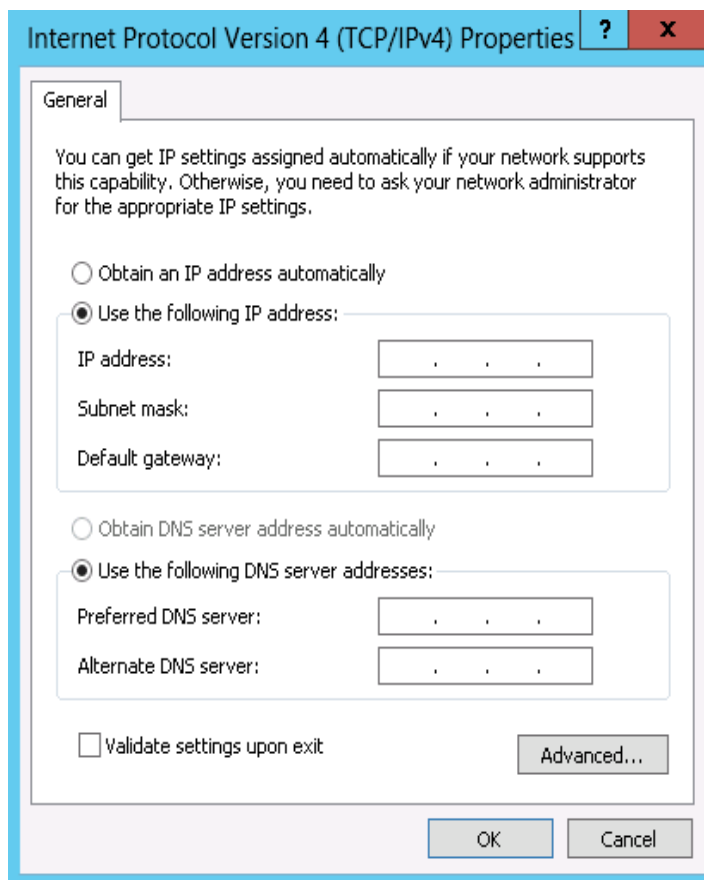

Step 5. Click OK.

Step 6. Close the Local Area Connection dialog.

Step 7. Verify the IP configuration by running ‘ipconfig’ from a CMD console.

```
> ipconfig
...
Ethernet adapter Local Area Connection 4:

    Connection-specific DNS Suffix  . :
    IP Address. . . . . : 11.4.12.63
    Subnet Mask . . . . . : 255.255.0.0
    Default Gateway . . . . . :
    ...
```

4.2.9 Port Type Management on Windows

After installing Mellanox WinOF VPI for Windows on your machine, you can change a port's protocol configuration. The following steps describe how to configure the port type:

Step 1: Display the Device Manager and expand “System Devices”.



Step 2: Right-click on the Mellanox ConnectX VPI network adapter and left-click Properties. Select the Port Protocol tab from the Properties sheet.

Note: The “Port Protocol” tab is displayed only if the NIC is a VPI (IB and ETH). If the NIC is either only IB or ETH, the tab will not be shown.

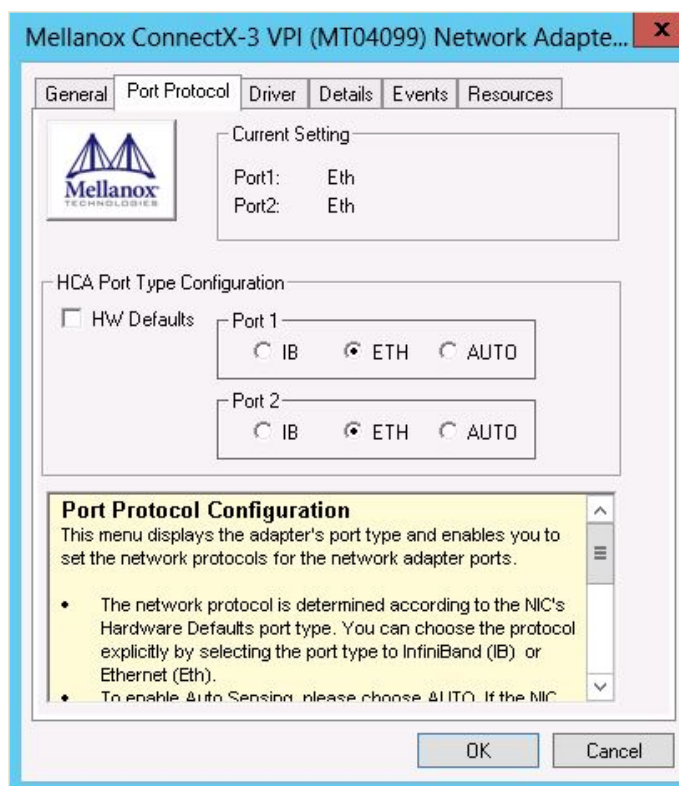

Step 3. In this step, you can perform two different functions: (a) Choose the desired port protocol for the available port(s), and (b) activate or deactivate the WSD, ND, and/or SDP ULPs.

Note: IB *must* be always the first port in Port 1. If you choose ETH as your first port in Port 1, then the second port in Port 2 can be only ETH.

Note: WSD is not supported in Windows 7. Consequently, on this OS the WSD checkbox is grayed out and cannot be selected.

4.3 Performance Tuning

For guidelines on improving network adapter performance, please refer to the performance tuning guidelines for a Linux/Windows environment in the document http://www.mellanox.com/related-docs/prod_software/Performance_Tuning_Guide_for_Mellanox_Network_Adapters.pdf.

4.4 VMware Driver

For VMware download and install the latest Mellanox OFED Driver for VMware® ESXi Server software package available via the Mellanox web site at: <http://www.mellanox.com> => Products => Software => InfiniBand/VPI Drivers => VMware Drivers => Download. Follow the installation instructions included in the download package (also available from the download page).

4.4.1 Installing Mellanox InfiniBand OFED Driver for VMware vSphere

This chapter describes how to install and test the Mellanox InfiniBand OFED Driver for VMware vSphere package on a single host machine with Mellanox InfiniBand hardware installed.

The InfiniBand OFED driver installation on VMware ESXi Server 5.0 is done using VMware's VIB bundles.



Please uninstall any previous Mellanox driver packages prior to installing the new version. Refer to “[Uninstalling Mellanox InfiniBand OFED Driver](#)” on page 54.

➤ To install the driver:

1. Log into the ESXi5.0 server with root permissions.
2. Install the driver.

```
#> esxcli software vib install -d <bundle_file>
```

3. Reboot the machine.
4. Verify the driver was installed successfully.

```
#> esxcli software vib list | grep Mellanox
net-ib-core          1.8.1 OEM.500.0.0.472560 Mellanox PartnerSupported 2013-02-09
net-ib-ipoib         1.8.1 OEM.500.0.0.472560 Mellanox PartnerSupported 2013-02-09
net-ib-mad            1.8.1 OEM.500.0.0.472560 Mellanox PartnerSupported 2013-02-09
net-ib-sa             1.8.1 OEM.500.0.0.472560 Mellanox PartnerSupported 2013-02-09
net-ib-umad          1.8.1 OEM.500.0.0.472560 Mellanox PartnerSupported 2013-02-09
net-mlx4-core        1.8.1 OEM.500.0.0.472560 Mellanox PartnerSupported 2013-02-09
net-mlx4-ib          1.8.1 OEM.500.0.0.472560 Mellanox PartnerSupported 2013-02-09
```



After the installation process, all kernel modules are loaded automatically upon boot.

4.4.2 Uninstalling Mellanox InfiniBand OFED Driver

➤ *To uninstall the driver:*

1. Log into the ESXi5.0 server with root permissions.
2. List the existing InfiniBand OFED driver modules.

```
#> esxcli software vib list | grep Mellanox
net-ib-core 1.8.1 OEM.500.0.0.472560 Mellanox Partner Supported 2013-02-09 net-ib-ipoib
1.8.1 OEM.500.0.0.472560 Mellanox Partner Supported 2013-02-09
...
```

3. Remove each module using the "esxcli software vib remove..." command.

```
#> esxcli software vib remove -n net-ib-ipoib
#> esxcli software vib remove -n net-mlx4-ib
#> esxcli software vib remove -n net-ib-umad
#> esxcli software vib remove -n net-ib-sa
#> esxcli software vib remove -n net-ib-mad
#> esxcli software vib remove -n net-ib-core
#> esxcli software vib remove -n net-mlx4-core
```

Reboot the server.

4.5 FlexBoot

FlexBoot supports remote Boot over InfiniBand (BoIB) and over Ethernet. This technology is based on the Preboot Execution Environment (PXE) standard specification, and FlexBoot software is based on the open source iPXE project (see www.ipxe.org). For more information go to <http://www.mellanox.com> => Products => Software => InfiniBand/VPI Drivers => Download.

5 Updating Adapter Card Firmware

Each card is shipped with the latest version of qualified firmware at the time of manufacturing. However, Mellanox issues firmware updates occasionally and the most recent firmware can be obtained from: <http://www.mellanox.com> => Support. Check that the firmware on your card is the latest found on the Mellanox site, if not update to the latest version found on the Mellanox web site.

Firmware can be updated on the stand-alone single card using the **flint** tool of the *Mellanox Firmware Tools (MFT)* package. This package is available for download, along with its user manual, from the Mellanox Firmware Tools page. See <http://www.mellanox.com> => Software => Firmware Tools.

The following steps describe how to retrieve the PSID (firmware identification) and programmed firmware version of your adapter card. They also describe how to update the card with the latest firmware version available.

1. Retrieve the PSID and firmware version:
 - a. Install the MFT package. The package is available at <http://www.mellanox.com> => Products => Software => Firmware Tools. Make sure to download the package corresponding to your computer's operating system.
 - b. Enter: `mst start`.
 - c. Get the Mellanox *mst device name* using the command "`mst status`". The mst device name will be of the form: `/dev/mst/mt4099_pci_cr0`.
 - d. Get the PSID (firmware identification) and programmed firmware version using the command.

Note: The shown versions and/or parameter values in the example below may not reflect the latest or actual values for this product, and are included here for illustration purposes only.

```
> flint -d /dev/mst/mt4103_pci_cr0 q
Image type:      ConnectX-3 Pro
FW Version:   2.9.4000
Device ID:       4103
Chip Revision:   0
Description:     Node          Port1          Port2
Sys image
GUIDs:          000002c900000200 000002c900000201 000002c900000202
000002c900000203
MACs:
000002c90200    000002c90201
Board ID:       (MT_1020110019)
VSD:
PSID:           MT_1020110019
```

1. Compare the programmed firmware version with the latest available.
 - a. Go to Mellanox's web site: <http://www.mellanox.com/supportdownloader>. See [Figure 6](#).
 - b. Enter your card PSID to display the latest firmware file. The file name of the binary is composed by combining the firmware name, the firmware release version, and the card part number.

Note: Please contact Mellanox System Support if you cannot find the firmware binary for your adapter card.

Figure 6: Support Download Assistant

Mellanox - Support Download Assistant

Support Index | Documentation Login | Customer Support | Returns | Home

CLEAR PSID or OPN

Browse for Product Support

Select a Family	Select a Line	Select an OPN	Select a PSID (Rev)	Product Support Information
Adapter Cards Switches Gateways	Select an item from previous column			

1. If a newer firmware version exists for your adapter card on the Web, update the firmware as follows:
 - a. Download the firmware (image) zip file from the Support Downloader (see Step 2a above).
 - b. Unzip the firmware image.
 - c. Burn the firmware image. Enter:

```
> flint -d /dev/mst/mt4099_pci_cr0 -i <binary image> burn
```

- a. Reboot the computer.
- b. Enter: mst start.
- c. Verify that the card firmware was updated successfully.

```
> flint -d /dev/mst/mt4103_pci_cr0 q
Image type:    ConnectX-3 Pro
FW Version:   2.9.4100
Device ID:    4103
...
```

6 Troubleshooting

6.1 General

<p>Server unable to find the adapter</p>	<ul style="list-style-type: none"> • Ensure that the adapter is placed correctly • Make sure the adapter slot and the adapter are compatible • Install the adapter in a different PCI Express slot • Use the drivers that came with the adapter or download the latest • Make sure your motherboard has the latest BIOS • Try to reboot the server
<p>The adapter no longer works</p>	<ul style="list-style-type: none"> • Reseat the adapter in its slot or a different slot, if necessary • Try using another cable • Reinstall the drivers for the network driver files may be damaged or deleted • Reboot the server
<p>Adapters stopped working after installing another adapter</p>	<ul style="list-style-type: none"> • Try removing and re-installing all adapters • Check that cables are connected properly • Make sure your motherboard has the latest BIOS
<p>Link indicator light is off</p>	<ul style="list-style-type: none"> • Ensure that adapter driver/s is loaded • Try another port on the switch • Make sure the cable is securely attached • Check your are using the proper cables that do not exceed the recommended lengths • Verify that your switch and adapter port are compatible
<p>Link light is on, but with no communication established</p>	<ul style="list-style-type: none"> • Check that the latest driver is loaded • Check that both the adapter and its link are set to the same speed and duplex settings

6.2 Linux

Environment Information	<pre>cat/etc/issue uname -a cat/proc/cupinfo grep 'model name' uniq ofed_info head -1 ifconfig -a ethtool <interface> ethtool -i <interface_of_Mellanox_port_num> ibdev2netdev</pre>
Card Detection	<pre>lspci grep -i Mellanox</pre>
Mellanox Firmware Tool (MFT)	<p>Download and install MFT: http://www.mellanox.com/content/pages.php?pg=management_tools&menu_section=34 Refer to the User Manual for installation instructions.</p> <p>Once installed, run:</p> <pre>mst start mst status flint -d <mst_device> q</pre>
Ports Information	<pre>ibstat lsv_devinfo</pre>
Firmware Version Upgrade	<p>To download the latest firmware version refer to http://www.mellanox.com/supportdownloader</p>
Collect Log File	<pre>/var/log/messages dmesg > system.logF</pre>

6.3 Windows

Environment Information	<p>From the Windows desktop choose the Start menu and run: msinfo32</p> <p>To export system information to a text file, choose the Export option from the File menu. Assign a file name and save.</p>
Mellanox Firmware Tool (MFT)	<p>Download and install MFT: http://www.mellanox.com/content/pages.php?pg=management_tools&menu_section=34 Refer to the User Manual for installation instructions.</p> <p>Once installed, open a CMD window and run: cd C:\Program Files\Mellanox\WinMFT mst start mst status flint -d <mst_device> q</p>
Ports Information	vstat
Firmware Version Upgrade	<p>Download the latest firmware version using the PSID/board ID: http://www.mellanox.com/supportdownloader/ flint -d <mst_device> -i <firmware_bin_file> b</p>
Collect log file	<ul style="list-style-type: none"> • Event log viewer • MST device logs: <ul style="list-style-type: none"> • mst start • mst status • C:\Users\Administrator> flint -d <mst_device> dc > dump_configuration.log • C:\Users\Administrator> mstdump <mst_device> dc > mstdump.log

7 Specifications

7.1 MCX353A-FCCT Specifications

Table 9 - MCX354A-FCCT Specifications Table

Physical	Size: 2.12in. x5.6 in. (53.59mm x 142.25 mm)
	Connector: QSFP+ InfiniBand (Copper and optical)
Protocol Support	InfiniBand: IBTA v1.2.1 Auto-Negotiation ^a : 1X/2X/4X SDR (2.5Gb/s per lane), DDR (5Gb/s per lane), QDR (10Gb/s per lane), FDR10 (10.3125Gb/s per lane), FDR (14.0625Gb/s per lane) port
	Ethernet: 10GBASE-CX4, 10GBASE-R, and 1000BASE-R, 40GBASE-R4
	Data Rate: Up to 56Gb/s FDR – InfiniBand 1/10/40/56Gb/s – Ethernet
	PCI Express Gen3: SERDES @ 8.0GT/s, 8 lanes (2.0 and 1.1 compatible)
Power and Environmental	Voltage: 12V, 3.3V
	Typ Power: Passive Cables 6.87W
	Max Power: Passive Cables 7.30W
	Max power available through QSFP+ port: 1.5W
	Temperature: Operational 0°C to 55°C Non-operational -20°C to 70°C
	Humidity: 90% relative humidity ^b
	Air Flow: 200LFM ^c
Regulatory	EMC: Refer to the following link: www.mellanox.com/related-docs/user_manuals/Regulatory_and_Compliance_Guide.pdf
	Safety: IEC/EN 60950-1:2006 ETSI EN 300 019-2-2 IEC 60068-2- 64, 29, 32
	RoHS: RoHS-R6
Cable Support	Please refer to www.mellanox.com => Products => Cables and Transceivers

- a. The ConnectX-3 Pro adapters supplement the IBTA auto-negotiation specification to get better bit error rates and longer cable reaches. This supplemental feature only initiates when connected to another Mellanox InfiniBand product.

- b. For both operational and non-operational states.
- c. Air flow is measured ~1” from the heat sink between the heat sink and the cooling air inlet.

7.2 MCX354A-FCCT Specifications

Table 10 - MCX354A-FCCT Specifications Table

Physical	Size: 2.71in. x5.6 in. (68.90mm x 142.25 mm)
	Connector: QSFP+ InfiniBand (Copper and optical)
Protocol Support	InfiniBand: IBTA v1.2.1 Auto-Negotiation ^a : 1X/2X/4X SDR (2.5Gb/s per lane), DDR (5Gb/s per lane), QDR (10Gb/s per lane), FDR10 (10.3125Gb/s per lane), FDR (14.0625Gb/s per lane) port
	Ethernet: 10GBASE-CX4, 10GBASE-R, and 1000BASE-R, 40GBASE-R4
	Data Rate: Up to 56Gb/s FDR– InfiniBand 1/10/40/56Gb/s – Ethernet
	PCI Express Gen3: SERDES @ 8.0GT/s, 8 lanes (2.0 and 1.1 compatible)
Power and Environmental	Voltage: 12V, 3.3V
	Typ Power: Passive Cables 8.24W
	Max Power: Passive Cables 8.99W
	Max power available through QSFP+ port: 1.5W
	Temperature: Operational 0°C to 55°C Non-operational -20°C to 70°C
	Humidity: 90% relative humidity ^b
	Air Flow: 200LFM ^c
Regulatory	EMC: Refer to the following link: www.mellanox.com/related-docs/user_manuals/Regulatory_and_Compliance_Guide.pdf
	Safety: IEC/EN 60950-1:2006 ETSI EN 300 019-2-2 IEC 60068-2- 64, 29, 32
	RoHS: RoHS-R6
Cable Support	Please refer to www.mellanox.com => Products => Cables and Transceivers

- a. The ConnectX-3 Pro adapters supplement the IBTA auto-negotiation specification to get better bit error rates and longer cable reaches. This supplemental feature only initiates when connected to another Mellanox InfiniBand product.

- b. For both operational and non-operational states.
- c. Air flow is measured ~1" from the heat sink between the heat sink and the cooling air inlet.

7.3 Adapter Led Operations

There are two I/O LEDs per port. See [Table 11](#) for different LED functions in InfiniBand mode and [Table 12](#) for different LED functions in Ethernet mode.

Table 11 - Physical and Logical Link Indications (InfiniBand Mode)

LED	Function
Green - physical link	<ul style="list-style-type: none"> • Constant on indicates a good physical link • Blinking indicates a problem with the physical link • If neither LED is lit, then the physical link has not been established
Yellow - logical (data activity) link	<ul style="list-style-type: none"> • A constant yellow indicates a valid logical (data activity) link without data transfer. • A blinking yellow indicates a valid logical link with data transfer • If only the green LED is lit and the yellow LED is off, then the logical link has not been established

Table 12 - Physical and Logical Link Indication (Ethernet Mode)

LED	Function
Green - physical link	<ul style="list-style-type: none"> • Constant on indicates a good physical link • If neither LED is lit, then the physical link has not been established
Yellow - logical (data activity) link	<ul style="list-style-type: none"> • A blinking yellow indicates activity (data transfer) • Stays off when there is no activity



The short bracket has the same port and LED footprints as the tall bracket.

7.4 Board Mechanical Drawing and Dimensions



All dimensions are in millimeters.
All the mechanical tolerances are +/- 0.1mm.

Figure 7: Mechanical Drawing of the Single-port MCX353A-FCCT Adapter Card

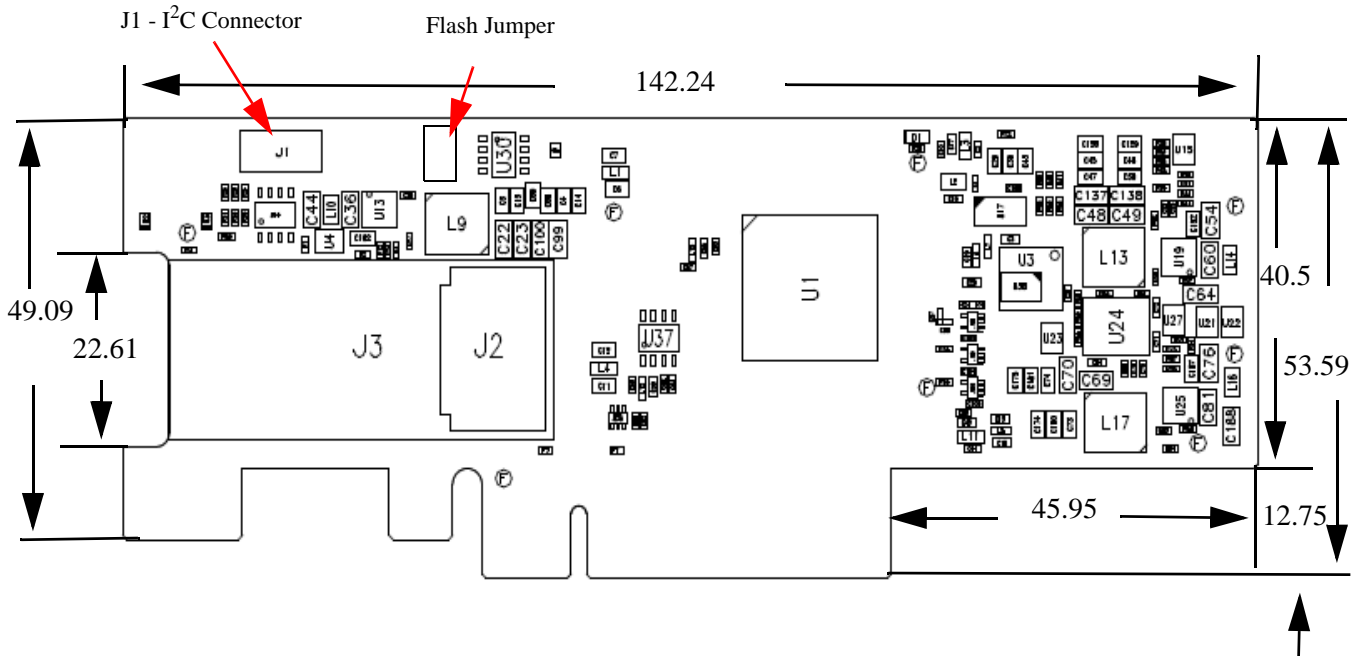
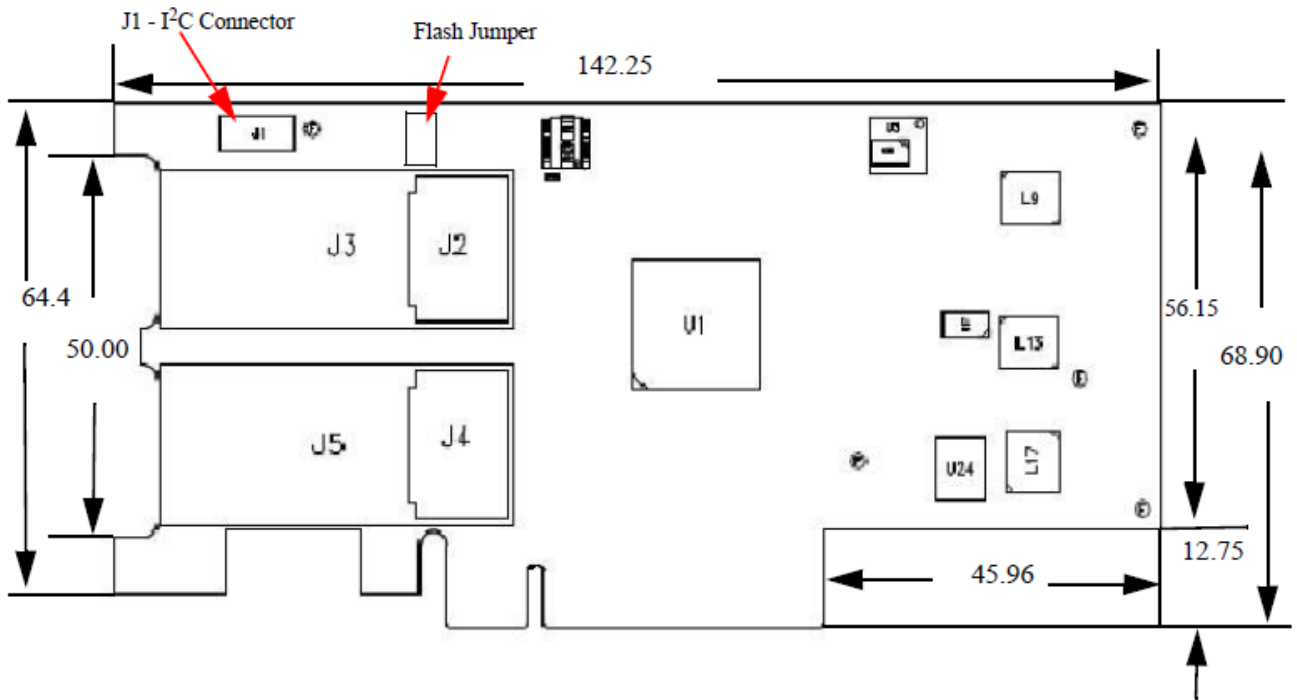

Figure 8: Mechanical Drawing of the Dual-port MCX354A-FCCT Adapter Card



7.5 Bracket Mechanical Drawing

Figure 9: Dual-port Bracket

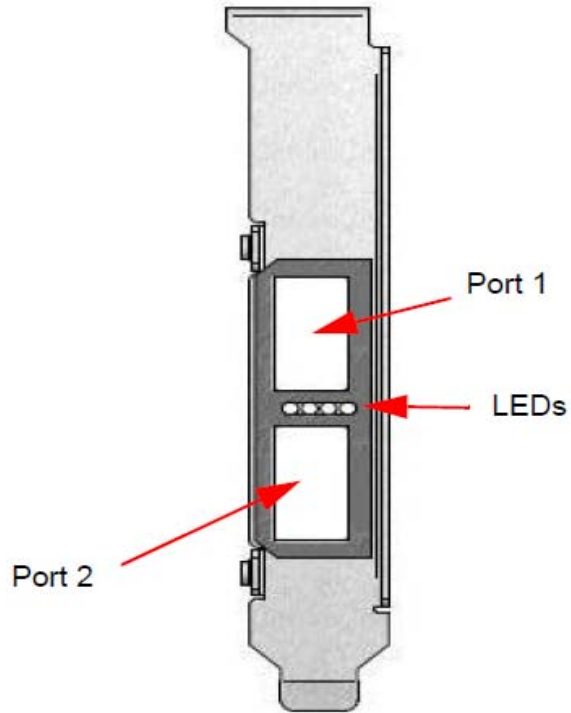
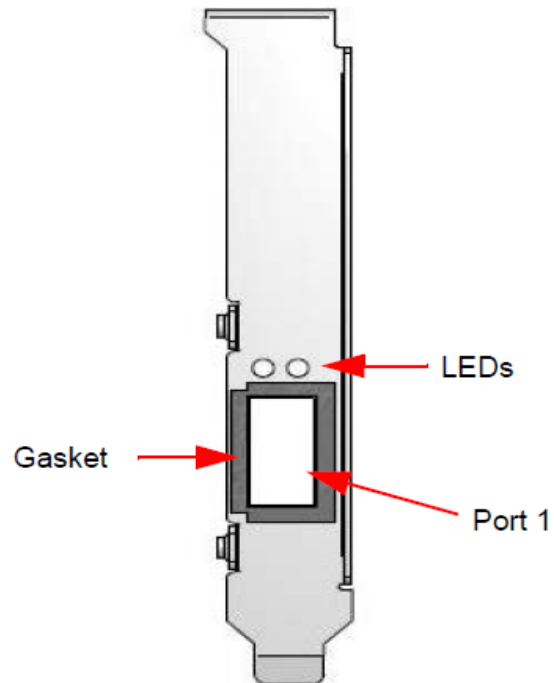

Figure 10: Single-port Bracket

7.6 Regulatory Statements

For regulatory statements for all ConnectX®-3 Pro cards please refer to:

http://www.mellanox.com/related-docs/user_manuals/Regulatory_and_Compliance_Guide.pdf

Appendix A: Interface Connectors Pinout

A.1 QSFP+ Connector Pinout

Figure 11: Connector and Cage Views

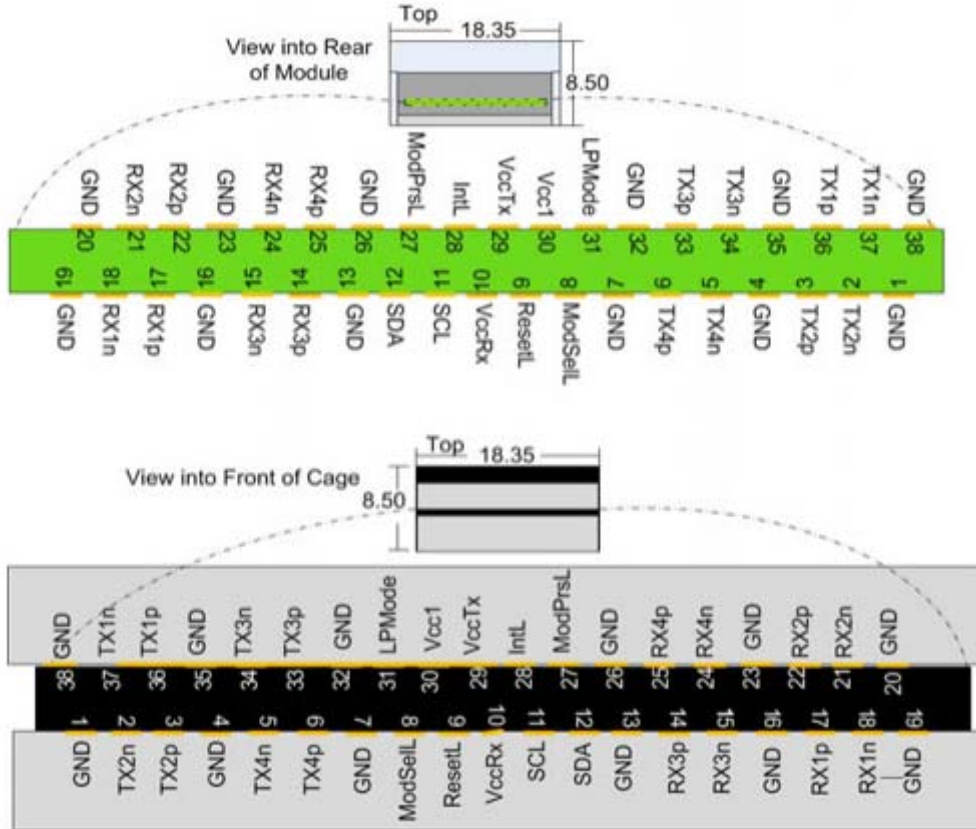

Table 13 - Connector Pin Number and Name to Signal Name Map

Connector Pin Number	Connector Pin Name	Port A Signal Name
1	GND	GND
2	TXN_2	Tx2n
3	TXP_2	Tx2p
4	GND	GND
5	TXN_4	Tx4n
6	TXP_4	Tx4p
7	GND	GND
8	ModSelL_Port0	ModSelL
9	ResetL_Port0	ResetL
10		VccRx
11	SCL	SCL

Table 13 - Connector Pin Number and Name to Signal Name Map

Connector Pin Number	Connector Pin Name	Port A Signal Name
12	SDA	SDA
13	GND	GND
14	RXP_3	Rx3p
15	RXN_3	Rx3n
16	GND	GND
17	RXP_1	Rx1p
18	RXN_1	Rx1n
19	GND	GND
20	GND	GND
21	RXN_2	Rx2n
22	RXP_2	Rx2p
23	GND	GND
24	RXN_4	Rx4n
25	RXP_4	Rx4p
26	GND	GND
27	ModPrsl_Port0	Mod PrsL
28	IntL	IntL
29		VccTx
30		Vcc1
31	LPMMode_Port0	LPMMode
32	GND	GND
33	TXP_3	Tx3p
34	TXN_3	Tx3n
35	GND	GND
36	TXP_1	Tx1p
37	TXN_1	Tx1n
38	GND	GND

A.2 PCI Express x8 Connector Pinout

The adapter cards use a standard PCI Express x8 edge connector and the PCI Express x8 standard pinout according to the PCI Express 3.0 specification.

Figure 12: PCIe Connector Pinout

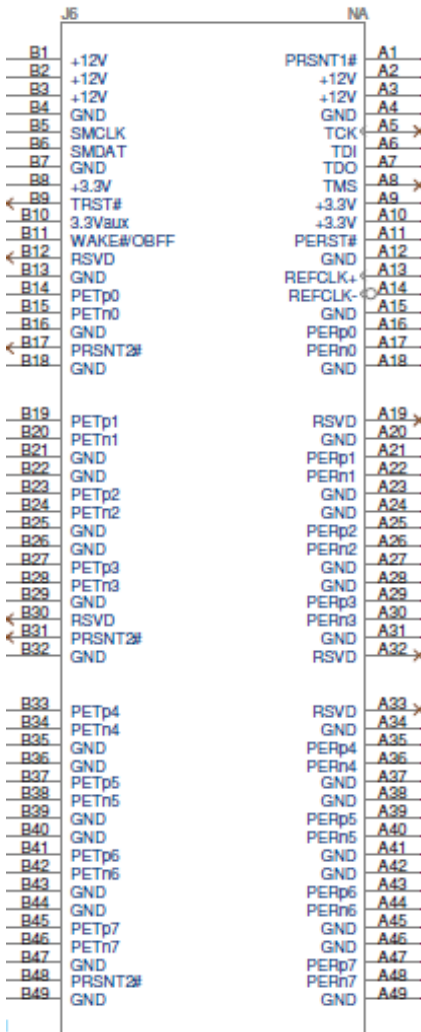

A.3 I²C-compatible Connector Pinout

Figure 13: Compatible Connector Plug and Pinout

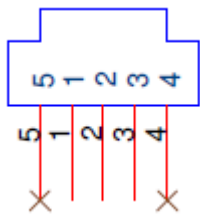

Connector Pin Number	Signal Name
1	SPSDA
2	SPSCL
3	GND
4	NC
5	NC

Appendix B: Finding the GUID/MAC and Serial Number on the Adapter Card

Each Mellanox adapter card has a different identifier printed on the label: serial number, the card MAC for the Ethernet protocol and the card GUID for the InfiniBand protocol. VPI cards have both a GUID and a MAC (derived from the GUID).

Figure 14: Card Product Label



Port 1 uses the GUID or MAC described on the label. To obtain the GUID or MAC for Port 2 on dual port cards, add 1 to the GUID or MAC of Port 1.

Appendix C: Safety Warnings

1. Installation Instructions



Read all installation instructions before connecting the equipment to the power source.

2. Over-temperature



This equipment should not be operated in an area with an ambient temperature exceeding the maximum recommended: 55°C (131°F).
To guarantee proper air flow, allow at least 8cm (3 inches) of clearance around the ventilation openings.

3. During Lightning - Electrical Hazard



During periods of lightning activity, do not work on the equipment or connect or disconnect cables.

4. Copper Cable Connecting/Disconnecting



Some copper cables are heavy and not flexible, as such they should be carefully attached to or detached from the connectors. Refer to the cable manufacturer for special warnings and instructions.

5. Equipment Installation



This equipment should be installed, replaced, or serviced only by trained and qualified personnel.

6. Equipment Disposal



Disposal of this equipment should be in accordance to all national laws and regulations.

7. Local and National Electrical Codes



This equipment should be installed in compliance with local and national electrical codes.

8. Hazardous Radiation Exposure



Caution – Use of controls or adjustment or performance of procedures other than those specified herein may result in hazardous radiation exposure.



CLASS 1 LASER PRODUCT and reference to the most recent laser standards:
IEC 60 825-1:1993 + A1:1997 + A2:2001 and EN 60825-1:1994+A1:1996+
A2:20.

Appendix D: Avertissements de sécurité d'installation (Warnings in French)

1. Instructions d'installation



Lisez toutes les instructions d'installation avant de brancher le matériel à la source d'alimentation électrique.

2. Température excessive



Ce matériel ne doit pas fonctionner dans une zone avec une température ambiante dépassant le maximum recommandé de 55°C (131°F). Un flux d'air de 200LFM à cette température ambiante maximale est nécessaire. En outre, pour garantir un bon écoulement de l'air, laissez au moins 8 cm (3 pouces) d'espace libre autour des ouvertures de ventilation.

3. Orages – dangers électriques



Pendant un orage, il ne faut pas utiliser le matériel et il ne faut pas brancher ou débrancher les câbles.

4. Branchement/débranchement des câbles en cuivre



Les câbles en cuivre sont lourds et ne sont pas flexibles, il faut donc faire très attention en les branchant et en les débranchant des connecteurs. Consultez le fabricant des câbles pour connaître les mises en garde et les instructions spéciales.

5. Installation du matériel



Ce matériel ne doit être installé, remplacé ou entretenu que par du personnel formé et qualifié.

6. Élimination du matériel



L'élimination de ce matériel doit s'effectuer dans le respect de toutes les législations et réglementations nationales en vigueur.

7. Codes électriques locaux et nationaux



Ce matériel doit être installé dans le respect des codes électriques locaux et nationaux.

8. Exposition au rayonnement grave



Mise en garde – l'utilisation de commandes ou de réglages ou l'exécution de procédures autres que ce qui est spécifié dans les présentes peut engendrer une exposition au rayonnement grave.



PRODUIT LASER DE CLASSE 1 » et références aux normes laser les plus récentes CEI 60 825-1:1993 + A1:1997 + A2:2001 et NE 60825-1:1994+A1:1996+ A2:2001

Appendix E: Sicherheitshinweise (Warnings in German)

1. Installationsanleitungen



Lesen Sie alle Installationsanleitungen, bevor Sie das Gerät an die Stromversorgung anschließen.

2. Übertemperatur



Dieses Gerät sollte nicht in einem Bereich mit einer Umgebungstemperatur über der maximal empfohlenen Temperatur von 55°C (131°F) betrieben werden. Es ist ein Luftstrom von 200 LFM bei maximaler Umgebungstemperatur erforderlich. Außerdem sollten mindestens 8 cm (3 in.) Freiraum um die Belüftungsöffnungen sein, um einen einwandfreien Luftstrom zu gewährleisten.

3. Bei Gewitter - Elektrische Gefahr



Arbeiten Sie während eines Gewitters und Blitzschlag nicht am Gerät, schließen Sie keine Kabel an oder ab.

4. Anschließen/Trennen von -Kupferkabel



Kupferkabel sind schwer und nicht flexible. Deshalb müssen sie vorsichtig an die Anschlüsse angebracht bzw. davon getrennt werden. Lesen Sie die speziellen Warnungen und Anleitungen des Kabelherstellers.

5. Geräteinstallation



Diese Gerät sollte nur von geschultem und qualifiziertem Personal installiert, ausgetauscht oder gewartet werden.

6. Geräteentsorgung



Die Entsorgung dieses Geräts sollte unter Beachtung aller nationalen Gesetze Bestimmungen erfolgen.

7. Regionale und nationale elektrische Bestimmungen



Dieses Gerät sollte unter Beachtung der regionalen und nationalen elektrischen Bestimmungen installiert werden.



This equipment should be installed in compliance with local and national electrical codes.

8. Strahlenkontakt



Achtung – Nutzung von Steuerungen oder Einstellungen oder Ausführung von Prozeduren, die hier nicht spezifiziert sind, kann zu gefährlichem Strahlenkontakt führen..



Klasse 1 Laserprodukt und Referenzen zu den aktuellsten Lasterstandards :
ICE 60 825-1:1993 + A1:1997 + A2:2001 und EN 60825-1:1994+A1:1996+
A2:2001

Appendix F: Advertencias de seguridad para la instalación (Warnings in Spanish)

1. Instrucciones de instalación



Antes de conectar el equipo a la fuente de alimentación, leer todas las instrucciones de instalación.

2. Sobrecalentamiento



No se debe utilizar el equipo en un área con una temperatura ambiente superior a la máxima recomendada: 55°C(131°F). Además, para garantizar una circulación de aire adecuada, se debe dejar como mínimo un espacio de 8 cm (3 pulgadas) alrededor de las aberturas de ventilación.

3. Cuando hay rayos: peligro de descarga eléctrica



No utilizar el equipo ni conectar o desconectar cables durante períodos de actividad de rayos.

4. Conexión y desconexión del cable Copper



Dado que los cables de cobre son pesados y no son flexibles, su conexión a los conectores y su desconexión se deben efectuar con mucho cuidado. Para ver advertencias o instrucciones especiales, consultar al fabricante del cable.

5. Instalación de equipos



La instalación, el reemplazo y el mantenimiento de este equipo estarán a cargo únicamente de personal capacitado y competente.

6. Eliminación de equipos



La eliminación definitiva de este equipo se debe efectuar conforme a todas las leyes y reglamentaciones nacionales.

7. Códigos eléctricos locales y nacionales



Este equipo se debe instalar conforme a los códigos eléctricos locales y nacionales.

8. Exposición a niveles de radiación peligrosos



Precaución: el uso de controles o ajustes o la realización de procedimientos distintos de los que aquí se especifican podrían causar exposición a niveles de radiación peligrosos.



PRODUCTO LÁSER DE CLASE 1 y referencia a las normas de láser más recientes:
IEC 60825-1:2007/03 y EN 60825-1:2007