



ConnectX[®]-3 Ethernet Single and Dual SFP+ Port Adapter Card User Manual

P/N:

MCX312A-XCBT, MCX312B-XCBT, MCX311A-XCAT

Rev 2.3

NOTE:

THIS HARDWARE, SOFTWARE OR TEST SUITE PRODUCT (“PRODUCT(S)”) AND ITS RELATED DOCUMENTATION ARE PROVIDED BY MELLANOX TECHNOLOGIES “AS-IS” WITH ALL FAULTS OF ANY KIND AND SOLELY FOR THE PURPOSE OF AIDING THE CUSTOMER IN TESTING APPLICATIONS THAT USE THE PRODUCTS IN DESIGNATED SOLUTIONS. THE CUSTOMER’S MANUFACTURING TEST ENVIRONMENT HAS NOT MET THE STANDARDS SET BY MELLANOX TECHNOLOGIES TO FULLY QUALIFY THE PRODUCT(S) AND/OR THE SYSTEM USING IT. THEREFORE, MELLANOX TECHNOLOGIES CANNOT AND DOES NOT GUARANTEE OR WARRANT THAT THE PRODUCTS WILL OPERATE WITH THE HIGHEST QUALITY. ANY EXPRESS OR IMPLIED WARRANTIES, INCLUDING, BUT NOT LIMITED TO, THE IMPLIED WARRANTIES OF MERCHANTABILITY, FITNESS FOR A PARTICULAR PURPOSE AND NONINFRINGEMENT ARE DISCLAIMED. IN NO EVENT SHALL MELLANOX BE LIABLE TO CUSTOMER OR ANY THIRD PARTIES FOR ANY DIRECT, INDIRECT, SPECIAL, EXEMPLARY, OR CONSEQUENTIAL DAMAGES OF ANY KIND (INCLUDING, BUT NOT LIMITED TO, PAYMENT FOR PROCUREMENT OF SUBSTITUTE GOODS OR SERVICES; LOSS OF USE, DATA, OR PROFITS; OR BUSINESS INTERRUPTION) HOWEVER CAUSED AND ON ANY THEORY OF LIABILITY, WHETHER IN CONTRACT, STRICT LIABILITY, OR TORT (INCLUDING NEGLIGENCE OR OTHERWISE) ARISING IN ANY WAY FROM THE USE OF THE PRODUCT(S) AND RELATED DOCUMENTATION EVEN IF ADVISED OF THE POSSIBILITY OF SUCH DAMAGE.



Mellanox Technologies
350 Oakmead Parkway Suite 100
Sunnyvale, CA 94085
U.S.A.
www.mellanox.com
Tel: (408) 970-3400
Fax: (408) 970-3403

© Copyright 2015. Mellanox Technologies. All Rights Reserved.

Mellanox®, Mellanox logo, BridgeX®, ConnectX®, Connect-IB®, CoolBox®, CORE-Direct®, InfiniBridge®, InfiniHost®, InfiniScale®, MetroX®, MLNX-OS®, TestX®, PhyX®, ScalableHPC®, SwitchX®, UFM®, Virtual Protocol Interconnect® and Voltaire® are registered trademarks of Mellanox Technologies, Ltd.

ExtendX™, FabricIT™, HPC-X™, Mellanox CloudX™, Mellanox Open Ethernet™, Mellanox PeerDirect™, Mellanox Virtual Modular Switch™, MetroDX™, Unbreakable-Link™ are trademarks of Mellanox Technologies, Ltd.

All other trademarks are property of their respective owners.

Table of Contents

Table of Contents	3
List of Figures	5
List of Tables	6
Revision History	7
About this Manual	9
Intended Audience	9
Related Documentation	9
Document Conventions	9
Technical Support	10
Firmware and Software Updates	10
Chapter 1 Introduction	11
1.1 Product Overview	11
1.2 Features and Benefits	12
1.3 Operating Systems/Distributions	12
1.4 Connectivity	13
Chapter 2 Interfaces	14
2.1 Ethernet SFP+ Interface	15
2.2 PCI Express Interface	16
2.3 I2C-compatible Interface	16
2.4 LED Interface	16
Chapter 3 Hardware Installation	17
3.1 System Requirements	17
3.1.1 Hardware	17
3.1.2 Operating Systems/Distributions	17
3.1.3 Software Stacks	17
3.2 Safety Precautions	17
3.3 Pre-installation Checklist	17
3.4 Bracket Installation Instructions	17
3.4.1 Removing the Existing Bracket	18
3.4.2 Installing the New Bracket	18
3.5 Card Installation Instructions	20
3.6 Cables and Modules	21
3.6.1 Inserting the Optical Transceiver Module	21
3.6.2 Cable Installation	21
3.7 Identify the Card in Your System	22
3.7.1 On Windows	22
3.7.2 On Linux	23
Chapter 4 Driver Installation	24
4.1 Linux Driver	24
4.1.1 Hardware and Software Requirements	24

4.1.2	Installing the Driver	24
4.1.3	Loading the Driver	25
4.1.4	Unloading the Driver	25
4.1.5	Uninstalling the Driver	25
4.2	Windows Driver	25
4.2.1	Hardware and Software Requirements	26
4.2.2	Downloading MLNX_WinOF	26
4.2.3	Extracting Files Without Running Installation	26
4.2.4	Installing MLNX_WinOF	28
4.2.4.1	Attended Installation	29
4.2.4.2	Unattended Installation	34
4.2.5	Upgrading MLNX_WinOF	35
4.2.6	Installation Results	35
4.2.7	OpenSM Activation	36
4.2.8	Uninstalling MLNX_WinOF	37
4.2.8.1	Attended Uninstall	37
4.2.8.2	Unattended Uninstall	37
4.2.9	Assigning Port IP After Installation	37
4.3	Performance Tuning	39
4.4	VMware Driver	40
4.4.1	Installing and Running the VBI Driver on ESXi-5.x	40
4.4.2	Installing and Running the offline_bundle Driver on ESXi-5.x	40
4.4.3	Removing the VIB/offline_bundle Driver	41
4.5	FlexBoot	41
Chapter 5	Updating Adapter Card Firmware	42
Chapter 6	Troubleshooting	44
6.1	General	44
6.2	Linux	45
6.3	Windows	46
Chapter 7	Specifications	47
7.1	MCX311A-XCAT Specifications	47
7.2	MCX312[AB]A-XCBT Specifications	48
7.3	Adapter LED Operation	49
7.4	Board Mechanical Drawing and Dimensions	50
7.5	Bracket Mechanical Drawing	52
7.6	Regulatory Statements	54
Appendix A	Interface Connectors Pinout	55
Appendix B	Finding the GUID/ MAC and Serial Number on the Adapter Card	59
Appendix C	Safety Warnings	61
Appendix D	Avertissements de sécurité d'installation (Warnings in French)	63
Appendix E	Sicherheitshinweise (Warnings in German)	65
Appendix F	Advertencias de seguridad para la instalación (Warnings in Spanish)	67

List of Figures

Figure 1:	MCX312A-XCBT Card	14
Figure 2:	MCX312B-XCBT Card	15
Figure 3:	MCX311A-XCAT Card	15
Figure 4:	Bracket Screws	18
Figure 5:	Placing the Bracket on the Card (MCX312A-XCBT)	19
Figure 6:	Placing the Bracket on the Card (MCX312B-XCBT)	19
Figure 7:	Placing the Bracket on the Card (MCX311A-XCAT)	20
Figure 8:	Module With Locking Mechanism Closed	21
Figure 9:	Module With Locking Mechanism Open	21
Figure 10:	PCI Device	22
Figure 11:	Support Download Assistant	43
Figure 12:	Mechanical Drawing of the Single-port MCX311A-XCAT Adapter Card	50
Figure 13:	Mechanical Drawing of the Dual-port MCX312A-XCBT Adapter Card	51
Figure 14:	Mechanical Drawing of the Dual-port MCX312B-XCBT	51
Figure 15:	Dual-port Bracket for MCX312A-XCBT	52
Figure 16:	Dual-port Bracket for MCX312B-XCBT	53
Figure 17:	Single-port Bracket	53
Figure 18:	Rear View of Module With Pin Placement	55
Figure 19:	PCIe Connector Pinout	57
Figure 20:	Compatible Connector Plug and Pinout	57
Figure 21:	Card Product Label (Example)	59
Figure 22:	Board Labels for MCX312B-XCBT	59

List of Tables

Table 1:	Revision History Table	7
Table 2:	Documents List	9
Table 3:	Single and Dual 10 Gigabit Ethernet Adapter Cards	11
Table 4:	Features	12
Table 5:	Software and Hardware Requirements	24
Table 6:	Software and Hardware Requirements	26
Table 7:	MCX311A-XCAT Specifications Table	47
Table 8:	MCX312[AB]-XCBT Specifications Table	48
Table 9:	Physical and Logical Link Indication	49
Table 10:	SFP+ Connector Pinout	56

Revision History

This document was printed on March 29, 2015.

Table 1 - Revision History Table

Date	Rev	Comments/Changes
May 2014	2.3	<ul style="list-style-type: none"> Added note on bracket replacement. See Section 3.4.2, “Installing the New Bracket,” on page 18.
April 2014	2.2	<ul style="list-style-type: none"> Added Section 4.3, “Performance Tuning,” on page 39 Added <i>Performance Tuning Guidelines</i> to “Related Documentation” on page 9
November 2013	2.1	<ul style="list-style-type: none"> Added the following note to Chapter 5, “Updating Adapter Card Firmware” on page 42 <ul style="list-style-type: none"> - Note: The shown versions and/or parameter values in the example below may not reflect the latest or actual values for this product, and are included here for illustration purposes only. Specified max power available through SFP+ ports in all specification tables. See Chapter 7, “Specifications” on page 47. Updated link to approved cables list in all specification tables. See Chapter 7, “Specifications” on page 47. Added “GUID of ConnectX-3 Ethernet adapter cards” to Section 6.1, “General,” on page 44 Added Appendix B.1, “Retrieving Adapter Card GUID,” on page 59
June 2013	2.0	Updated User Manual structure
February 2013	1.8	<ul style="list-style-type: none"> Added Section 4.4, “VMware Driver,” on page 40 Updated Figure 10, “PCI Device,” on page 22 Updated all Web links in the User Manual Updated the below: <ul style="list-style-type: none"> - Figure 12, “Mechanical Drawing of the Single-port MCX311A-XCAT Adapter Card,” on page 50 - Figure 12, “Mechanical Drawing of the Single-port MCX311A-XCAT Adapter Card,” on page 50
November 2012	1.8	<ul style="list-style-type: none"> Added MCX312B-XCBT to the following locations: <ul style="list-style-type: none"> - Section 1.4, “Connectivity,” on page 13 - Figure 2, “MCX312B-XCBT Card,” on page 15 - Figure 16, “Dual-port Bracket for MCX312B-XCBT,” on page 53 - Table 15, “MCX312B-XCBT VPD Layout,” on page 33
November 2012	1.7	- Updated Web links
October 2012	1.6	<ul style="list-style-type: none"> Added single-port SFP+ card to all necessary locations Fixed Table 5, “Jumper Configuration,” on page 17 Updated figures in Section 4.2, “Windows Driver,” on page 25 by providing ConnectX-3 examples
October 2012	1.5	Removed all references to 40 Gigabit Ethernet from the User Manual
August 2012	1.4	<ul style="list-style-type: none"> Added operational and non-operational temperature and humidity level to the following tables: <ul style="list-style-type: none"> - Table 8, “MCX312[AB]-XCBT Specifications Table,” on page 48

Date	Rev	Comments/Changes
January 2012	1.2	<ul style="list-style-type: none">• Minor edits• Updated LED functions in Section 2.3, “I2C-compatible Interface,” on page 16• Formatted specification tables in Appendix 7, “Specifications,” on page 47
October 2011	1.1	Added new OPNs based on ConnectX-3 Step A1 devices
July 2011	1.0	Minor edits
July 2011	0.10	First Release

About this Manual

This *User Manual* describes Mellanox Technologies ConnectX®-3 10 Gigabit Ethernet Single and Dual SFP+ port PCI Express x4 or x8 adapter cards. It provides details as to the interfaces of the board, specifications, required software and firmware for operating the board, and relevant documentation.

Intended Audience

This manual is intended for the installer and user of these cards.

The manual assumes basic familiarity with Ethernet networks and architecture specifications.

Related Documentation

Table 2 - Documents List

<i>Mellanox Firmware Tools (MFT) User Manual</i> Document no. 2204UG	User Manual describing the set of MFT firmware management tools for a single node. See http://www.mellanox.com => Products => Software => Firmware Tools
<i>MLNX_EN for Linux README Driver Kit for Mellanox Adapter Cards with 10/40GigE Support</i> Document no. 2950	This document provides information on the MLNX_EN Linux driver and instructions for installing the driver on Mellanox ConnectX adapter cards supporting 10Gb/s Ethernet.
<i>WinOF VPI for Windows User Manual</i> Document no. 3280	User Manual describing WinOF features, performance, InfiniBand diagnostic, tools content and configuration. See http://www.mellanox.com => Products => Software => Windows SW/Drivers => Mellanox OFED for Windows (WinOF)
<i>Mellanox MLX4_EN Driver for VMware README</i> Document no. 3527	User Manual describing MLX4_EN driver for VMware features, performance, diagnostic, tools content and configuration. See http://www.mellanox.com => Products => Software => Ethernet Drivers => VMware Drivers
<i>Performance Tuning Guidelines for Mellanox Network Adapters</i> Document no. 3368	Manual describes important tuning parameters and settings that can improve performance for Mellanox drivers.
<i>IEEE Std 802.3 Specification</i>	This is the IEEE Ethernet specification http://standards.ieee.org/getieee802
<i>PCI Express 3.0 Specifications</i>	Industry Standard PCI Express 3.0 Base and Card Electromechanical Specifications

Document Conventions

When discussing memory sizes, MB and MBytes are used in this document to mean size in mega Bytes. The use of Mb or Mbits (small b) indicates size in mega bits. In this document PCIe is used to mean PCI Express.

Technical Support

Customers who purchased Mellanox products directly from Mellanox are invited to contact us through the following methods.

- URL: <http://www.mellanox.com> => Support
- E-mail: support@mellanox.com
- Tel: +1.408.916.0055

Customers who purchased Mellanox M-1 Global Support Services, please see your contract for details regarding Technical Support.

Customers who purchased Mellanox products through a Mellanox approved reseller should first seek assistance through their reseller.

Firmware and Software Updates

The Mellanox support downloader contains software, firmware and knowledge database information for Mellanox products. Access the database from the Mellanox Support web page,

<http://www.mellanox.com> => Support

or use the following link to go directly to the Mellanox Support Download Assistant page,

<http://www.mellanox.com/supportdownloader/>.

1 Introduction

This is the User Guide for Mellanox Technologies Ethernet adapter cards based on the ConnectX®-3 EN integrated circuit device. These adapters connectivity provide the highest performing and most flexible interconnect solution for PCI Express Gen3 servers used in Enterprise Data Centers, High-Performance Computing, and Embedded environments

This chapter covers the following topics:

- Section 1.1, “Product Overview,” on page 11
- Section 1.2, “Features and Benefits,” on page 12
- Section 1.3, “Operating Systems/Distributions,” on page 12
- Section 1.4, “Connectivity,” on page 13

1.1 Product Overview

The following tables provide the ordering part number, port speed, number of ports, and PCI Express speed. Each adapter comes with two bracket heights - short and tall.

Table 3 - Single and Dual 10 Gigabit Ethernet Adapter Cards

Ordering Part Number (OPN)	MCX31[2/1]A-XCBT MCX312B-XCBT
Data Transmission Rate	10GbE
Number of ports	MCX312[A/B]-XCBT: dual-port QSFP+ MCX311A-XCBT: single-port QSFP+
PCI Express SERDES Speed	PCIe 3.0 x4/x8 8GT/s
RoHS	R6
Adapter IC Part Number	MT27518A1-FCCR-XE
Device ID (decimal)	4099 for Physical Function 4100 for Virtual Function

1.2 Features and Benefits

Table 4 - Features

PCI Express (PCIe)	Uses PCIe Gen 3.0 (1.1 and 2.0 compatible) through anx4 or x8 edge connector up to 8GT/s
10 Gigabit Ethernet	Mellanox adapters comply with the following IEEE 802.3* standards: IEEE Std 802.3-2008 Ethernet IEEE Std 802.3ae 10 Gigabit Ethernet IEEE Std 802.3ad Link Aggregation and Failover
Memory	PCI Express - stores and accesses InfiniBand and/or Ethernet fabric connection information and packet data SPI - includes one 16Mb SPI Flash device (M25PX16-VMN6P device by ST Microelectronics) EEPROM - accessible through the I ² C-compatible interface. The EEPROM capacity is 4Kb.
RDMA over Converged Ethernet (RoCE)	Leveraging Data Center Bridging capabilities, RoCE provides efficient low latency RDMA services over Layer 2 Ethernet.
CPU offload	Adapter functionality enabling reduced CPU overhead allowing more available CPU
GPUDirect RDMA	Using GPUDirect RDMA, adapters can directly read and write CUDA host and device memory, eliminating unnecessary system memory copies and CPU overhead, resulting in significant performance improvements.
Sockets Acceleration	Applications utilizing TCP/UDP/IP transport can achieve industry leading throughput over InfiniBand or 10 or 40GbE. The hardware-based stateless offload engines in ConnectX-3 reduce the CPU overhead of IP packet transport. Sockets acceleration software further increases performance for latency sensitive applications.
Quality of Service (QoS)	Support for port-based Quality of Service enabling various application requirements for latency and SLA
Hardware-based I/O virtualization	ConnectX-3 provides dedicated adapter resources and guaranteed isolation and protection for virtual machines within the server.
SR-IOV	ConnectX-3 Pro SR-IOV technology provides dedicated adapter resources and guaranteed isolation and protection for virtual machines (VM) within the server. I/O virtualization with ConnectX-3 Pro gives data center managers better server utilization while reducing cost, power, and cable complexity.
Storage Acceleration	A consolidated compute and storage network achieves significant cost-performance advantages over multi-fabric networks. Standard block and file access protocols can leverage InfiniBand RDMA for high-performance storage access.

1.3 Operating Systems/Distributions

- Citrix XenServer 6.1
- Novell SLES, Red Hat Enterprise Linux(RHEL), and other Linux distributions

- Microsoft Windows Server 2008/2012
- OpenFabrics Enterprise Distribution (OFED)
- OpenFabrics Windows Distribution (WinOF)
- Ubuntu 12.04
- VMware ESXi 4.x and 5.x

1.4 Connectivity

- Interoperable with InfiniBand or 10/40 Gb Ethernet switches.
- Interoperable with 56GbE Mellanox Switches.
- Passive copper cable with ESD protection
- Powered connectors for optical and active cable support
- QSFP to SFP+ connectivity through QSA module

2 Interfaces

Each adapter card includes the following interfaces:

- “Ethernet SFP+ Interface”
- “PCI Express Interface”
- “I2C-compatible Interface”
- “LED Interface”

Figure 1: MCX312A-XCBT Card

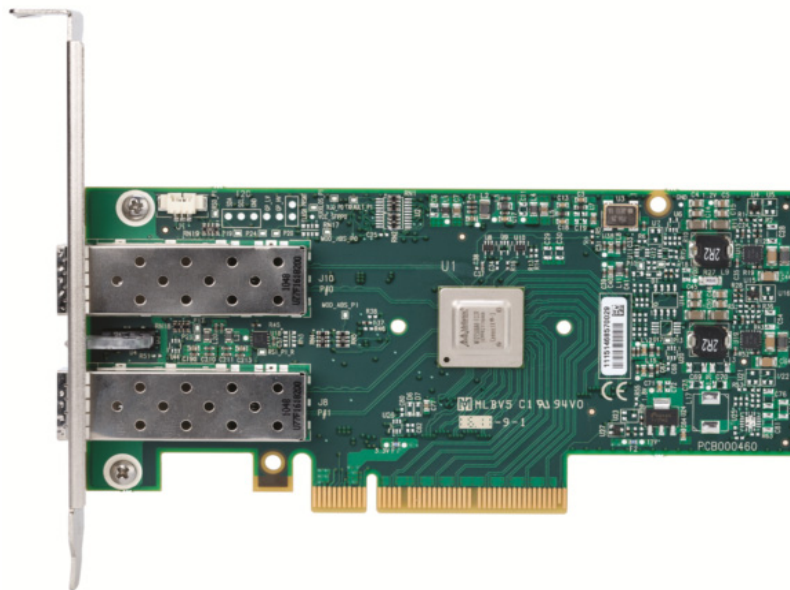
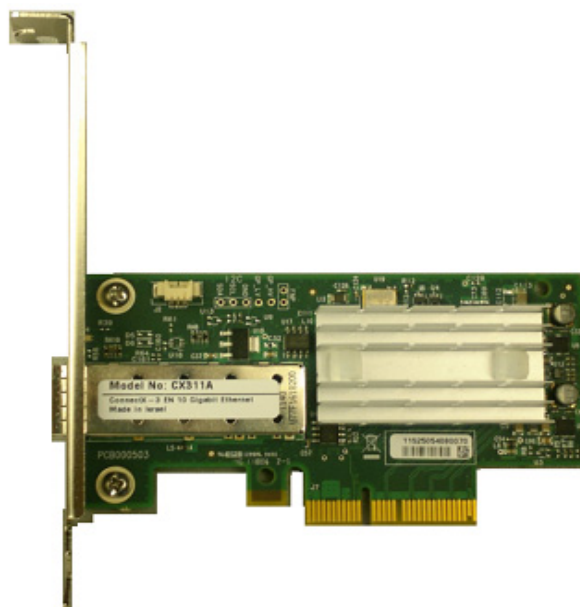

Figure 2: MCX312B-XCBT Card**Figure 3: MCX311A-XCAT Card**

The adapter cards include special circuits to protect from ESD shocks to the card/server when plugging copper cables.

2.1 Ethernet SFP+ Interface

The network ports of the ConnectX®-3 adapter cards are compliant with the IEEE 802.3 Ethernet standards listed in [Table 4, “Features,” on page 12](#). The SFP+ port has one Tx/Rx pair of SerDes. Ethernet traffic is transmitted through the cards' SFP+ connectors.

2.2 PCI Express Interface

The ConnectX®-3 adapter cards support PCI Express 3.0 (1.1 and 2.0 compatible) through an x4 or x8 edge connector. The device can be either a master initiating the PCI Express bus operations or a slave responding to PCI bus operations. The following lists the PCIe interface features:

- PCIe Base 3.0 compliant, 1.1 and 2.0 compatible
- 2.5, 5.0, or 8.0GT/s link rate x8
- Auto-negotiates to x8, x4, x2, or x1
- Support for MSI/MSI-X mechanisms

2.3 I²C-compatible Interface

A three-pin header on the adapter cards is provided as the I²C-compatible interface. See [Figure 13, “Mechanical Drawing of the Dual-port MCX312A-XCBT Adapter Card,” on page 51.](#) for the location on the board.

2.4 LED Interface

There are two I/O LEDs per port. For LED specifications please refer to [Figure 13, “Mechanical Drawing of the Dual-port MCX312A-XCBT Adapter Card,” on page 51.](#)

3 Hardware Installation

3.1 System Requirements

3.1.1 Hardware

A system with a PCI Express x4 or x8 slot is required for installing the card.

3.1.2 Operating Systems/Distributions

Please refer to [Section 1.3, “Operating Systems/Distributions,”](#) on page 12.

3.1.3 Software Stacks

Mellanox OpenFabric software package - MLNX_EN for Linux, WinOF for Windows and ESX 5.1 for VMware. See [Chapter 4, “Driver Installation”](#).

3.2 Safety Precautions



The adapter is being installed in a system that operates with voltages that can be lethal. Before opening the case of the system, observe the following precautions to avoid injury and prevent damage to system components.

1. Remove any metallic objects from your hands and wrists.
2. Make sure to use only insulated tools.
3. Verify that the system is powered off and is unplugged.
4. It is strongly recommended to use an ESD strap or other antistatic devices.

3.3 Pre-installation Checklist

1. Verify that your system meets the hardware and software requirements stated above.
2. Shut down your system if active.
3. After shutting down the system, turn off power and unplug the cord.
4. Remove the card from its package. Please note that the card must be placed on an antistatic surface.
5. Check the card for visible signs of damage. Do not attempt to install the card if damaged.

3.4 Bracket Installation Instructions

The card is usually shipped with a tall bracket installed. If this form factor is suitable for your requirements, you can skip the remainder of this section and move to [Section 3.5, “Card Installation Instructions,”](#) on page 20. If you need to replace it with the short bracket that is included in the shipping box, please follow the instructions in this section.

To replace the bracket you will need the following parts:

- The new bracket of the proper height
- One new gasket

- The 2 screws saved from the removal of the bracket
- The 2 fiber washers saved from the removal of the bracket

3.4.1 Removing the Existing Bracket

Figure 4: Bracket Screws

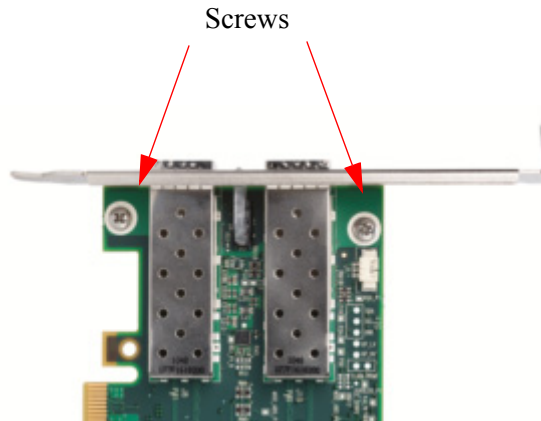

1. Remove the two screws holding the bracket in place. The bracket comes loose from the card.



Be careful not to put stress on the LEDs.

2. Save the two screws and the two fiber washers.

3.4.2 Installing the New Bracket

Note: Due to risk of damaging the EMI gasket, it is not recommended to replace the bracket more than three times.

1. Place the bracket onto the card until the screw holes line up. See [Figure 5](#).



Do not force the bracket onto the card. You may have to gently push the LEDs using a small screwdriver to align the LEDs with the holes in the bracket.

2. Screw on the bracket using the screws and washers saved from the bracket removal procedure above.

Figure 5: Placing the Bracket on the Card (MCX312A-XCBT)

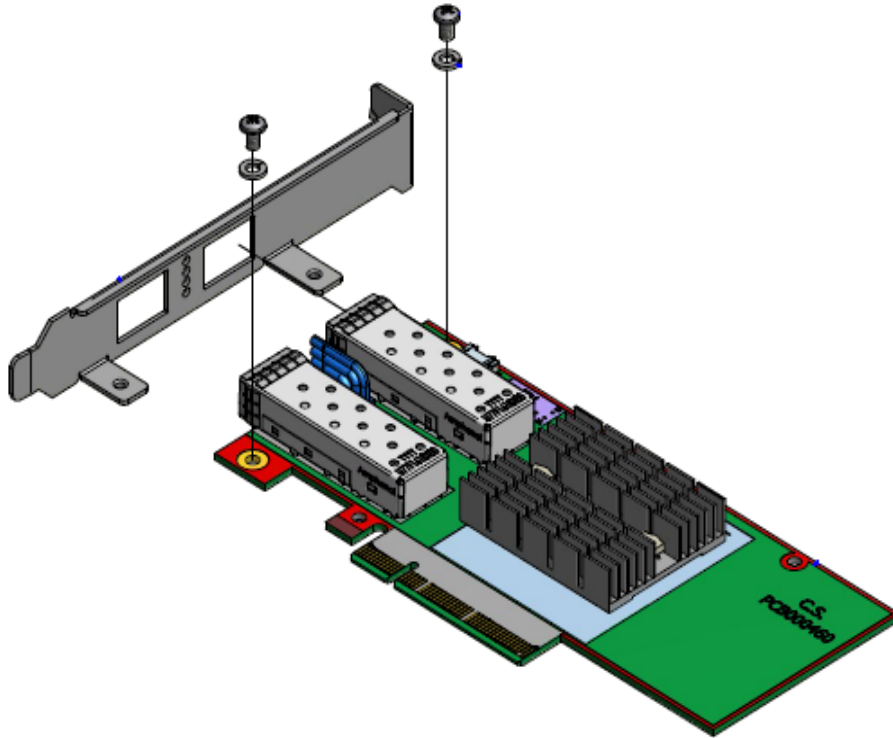

Figure 6: Placing the Bracket on the Card (MCX312B-XCBT)

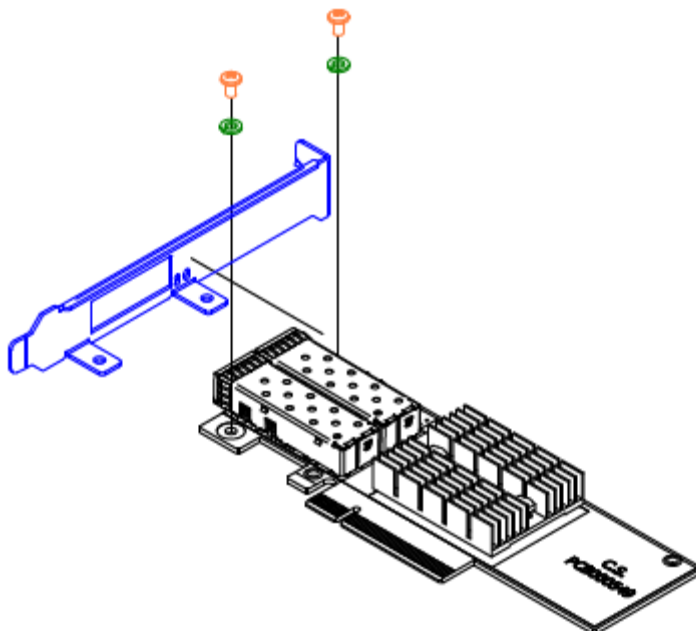
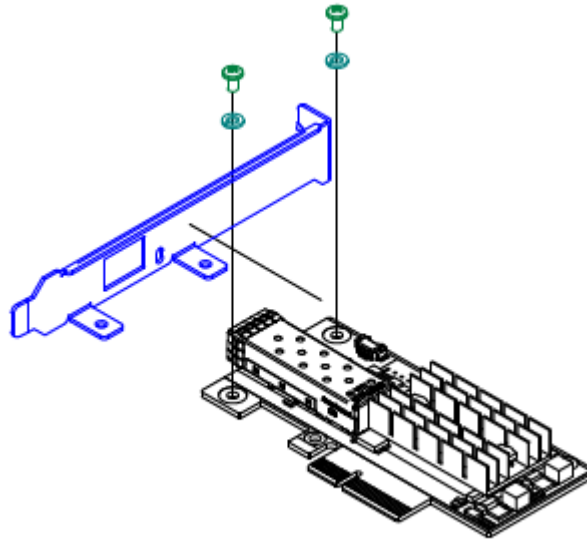

Figure 7: Placing the Bracket on the Card (MCX311A-XCAT)



3. Make sure that the LEDs are aligned onto the bracket holes.
4. Use a torque driver to apply up to 2 lbs-in torque on the screws.

3.5 Card Installation Instructions

1. Before installing the card, make sure that the system is off and the power cord is not connected to the server. Please follow proper electrical grounding procedures.
2. Open the system case.
3. Place the adapter in an available PCI Express slot.



A lesser width adapter can be seated into a greater width slot (x4 in a x8), but a greater width adapter cannot be seated into a lesser width slot (x8 in a x4). Align the adapter connector edge with the PCI Express connector slot.

4. Applying even pressure at both corners of the card, insert the adapter card into the slot until it is firmly seated. When the adapter is properly seated, the adapter port connectors are aligned with the slot opening, and the adapter faceplate is visible against the system chassis.



Do not use excessive force when seating the card, as this may damage the system or the adapter.

5. Secure the adapter with the adapter clip or screw.
6. Close the system case.

3.6 Cables and Modules

To obtain the list of supported cables for your adapter, please refer to “Mellanox Products Approved Cable Lists” at:

www.mellanox.com/related-docs/user_manuals/Mellanox_approved_cables.pdf.

3.6.1 Inserting the Optical Transceiver Module

To insert the module into the cage:

1. Open the module’s locking mechanism – see Figure 8 and Figure 9.
2. Make sure that the male connectors on the module will align with the female connectors inside of the cage. Also check that there is no dirt or foreign matter in the module or in the cage.

Figure 8: Module With Locking Mechanism Closed



Figure 9: Module With Locking Mechanism Open



3. Insert the module into the adapter card module cage.
4. Close the locking Mechanism.

To remove the module from the cage:

1. Unlock the locking mechanism by opening the handle.
2. Pull the module out of the cage.

3.6.2 Cable Installation

1. All cables can be inserted or removed with the unit powered on.
2. To insert a cable, press the connector into the port receptacle until the connector is firmly seated.



When installing cables make sure that the latches engage.



Always install and remove cables by pushing or pulling the cable and connector in a straight line with the card.

3. After inserting a cable into a port, the Green LED indicator will light when the physical connection is established (that is, when the unit is powered on and a cable is plugged into the port with the other end of the connector plugged into a functioning port). See [Section 7.3, “Adapter LED Operation,”](#) on page 49.
4. After plugging in a cable, lock the connector using the latching mechanism particular to the cable vendor. When a logical connection is made the Yellow LED will light. When data is being transferred the yellow led will blink. See [Section 7.3, “Adapter LED Operation,”](#) on page 49.
5. Care should be taken as not to impede the air exhaust flow through the ventilation holes. Use cable lengths which allow for routing horizontally around to the side of the chassis before bending upward or downward in the rack.
6. To remove a cable, disengage the locks and slowly pull the connector away from the port receptacle. Both LED indicators will turn off when the cable is unseated.

3.7 Identify the Card in Your System

3.7.1 On Windows

1. Open Device Manager on the server. Click start => Run, and then enter “devmgmt.msc”.
2. Expand System Devices and locate your Mellanox ConnectX-3 adapter card.
3. Right click the mouse on your adapter's row and select properties to display the adapter card properties window.
4. Click the Details tab and select Device Instance Id (Windows 2003) or
5. Hardware Ids (Windows 2008/R2) from the Properties pull-down menu.

Figure 10: PCI Device

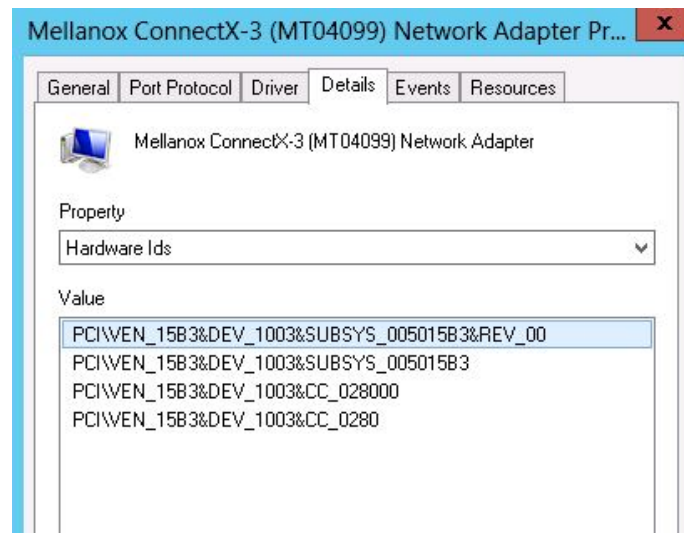

6. In the Value display box, check the fields VEN and DEV (fields are separated by '&'). In the display example above, notice the sub-string “PCI\VEN_15B3&DEV_1003”: VEN is equal to 0x15B3 – this is the Vendor ID of Mellanox Technologies; and DEV is equal to 1003 – this is a valid Mellanox Technologies PCI Device ID.



If the PCI device does not have a Mellanox adapter ID, return to Step 2 to check another device.



The list of Mellanox Technologies PCI Device IDs can be found in the PCI ID repository at <http://pci-ids.ucw.cz/read/PC/15b3>.

3.7.2 On Linux

Get the device location on the PCI bus by running `lspci` and locating lines with the string “Mellanox Technologies”:

```
> lspci |grep -i Mellanox  
27:00.0 Network controller: Mellanox Technologies MT27500 Family [ConnectX-3]
```

4 Driver Installation

4.1 Linux Driver

For Linux, download and install the latest MLNX_EN driver software package available via the Mellanox web site at: <http://www.mellanox.com> => Products => Software => Ethernet Drivers => ConnectX®-3 EN 10GigE Linux Driver => Download. Follow the installation instructions included in the download package (also available from the download page).

4.1.1 Hardware and Software Requirements

Table 5 - Software and Hardware Requirements

Requirements	Description
Platforms	CPU architectures: <ul style="list-style-type: none"> • x86_64 • x86 • power-pc
Device ID	For the latest list of device IDs, please visit http://pci-ids.ucw.cz/read/PC/15b3 .
Operating System	Linux Operating Systems: <ul style="list-style-type: none"> • RedHat EL5.8 • RedHat EL5.9 • RedHat EL6.2 • RedHat EL6.3 • OEL6.2 + 2.6.32-279.19.1 • OEL6.3 + 2.6.32-279.19.1 • SLES11 SP1 • SLES11 SP2
Software Dependencies	To install the driver software, kernel sources must be installed on the machine. MLNX_EN driver cannot coexist with OFED software on the same machine. Hence when installing MLNX_EN all OFED packages should be removed (done by the mlnx_en install script)

4.1.2 Installing the Driver

Step 1. Download Driver Package

Please download the current driver package from <http://www.mellanox.com> => Products => Software => Ethernet Driver => Linux Driver => Download.

Step 2. Install Driver

Run the following commands to install the driver:

```
#> tar xzvf mlnx_en-1.5.10.tgz file
#> cd mlnx_en-1.5.10
#> ./install.sh
```

The package consists of several source RPMs. The install script rebuilds the source RPMs and then installs the created binary RPMs. The created kernel module binaries are placed under /lib/modules/<kernel-ver>/updates/kernel/drivers/net/mlx4. mlnx_en installer supports 2 modes of

installation. The install scripts select the mode of driver installation depending on the running OS/kernel version.

1. Kernel Module Packaging (KMP) mode, where the source rpm is rebuilt for each installed flavor of the kernel. This mode is used for RedHat and SUSE distributions.
2. Non KMP installation mode, where the sources are rebuilt with the running kernel. This mode is used for vanilla kernels.

Note: If the Vanilla kernel is installed as rpm, please use the "--disable-kmp" flag when installing the driver.

The kernel module sources are placed under `/usr/src/mellanox-mlnx-en-1.5.10/`. Run the following commands to recompile the driver:

```
#> cd /usr/src/mellanox-mlnx-en-1.5.10/  
#> scripts/mlnx_en_patch.sh  
#> make  
#> make install
```

The uninstall and performance tuning scripts are installed.

Note: If the driver was installed without kmp support, the sources would be located under `/usr/src/mlnx_en-1.5.10/`

4.1.3 Loading the Driver

Step 1. Make sure no previous driver version is currently loaded

Run:

```
#> modprobe -r mlx4_en
```

Step 2. Load the new driver version

Run:

```
#> modprobe mlx4_en
```

The result is a new net-device appearing in 'ifconfig -a' output.

4.1.4 Unloading the Driver

To unload the Ethernet driver run:

```
#> modprobe mlx4_en
```

4.1.5 Uninstalling the Driver

To uninstall the `mlnx_en` driver run:

```
#> /sbin/mlnx_en_uninstall.sh
```

4.2 Windows Driver

For Windows, download and install the latest Mellanox WinOF VPI for Windows software package available via the Mellanox web site at: <http://www.mellanox.com> => Products => Software

=> Ethernet Drivers=> Windows SW/Driver => Download. Follow the installation instructions included in the download package (also available from the download page).

4.2.1 Hardware and Software Requirements

Table 6 - Software and Hardware Requirements

Requirements	Description
Required Disk Space for Installation	100 MB
Operating Systems	Windows Server 2012 (64 bit only) Windows Server 2008 R2 (64 bit only)
Installer Privileges	The installation requires administrator privileges on the target machine.

4.2.2 Downloading MLNX_WinOF

Follow these steps to download the .exe according to your Operating System.

Step 1. Verify the machine architecture.

1. Open a CMD console (Click start-->Run and enter CMD).
2. Enter the following command:

```
> echo %PROCESSOR_ARCHITECTURE%
```

On an x64 (64-bit) machine, the output will be “AMD64”.

Step 2. Go to the MLNX_WinOF for Windows Web page at <http://www.mellanox.com> => Products => Software => Ethernet Drivers => Windows SW/Drivers.

Step 3. Download the .exe image according to the architecture of your machine (see Step 1.). The name of the .exe is in the following format MLNX_VPI_WinOF-<version>_All_<OS>_<arch>.exe.



Installing the incorrect .exe file is prohibited. If you do so, an error message will be displayed.

For example, if you try to install a 64-bit .exe on a 32-bit machine, the wizard will display the following (or a similar) error message:

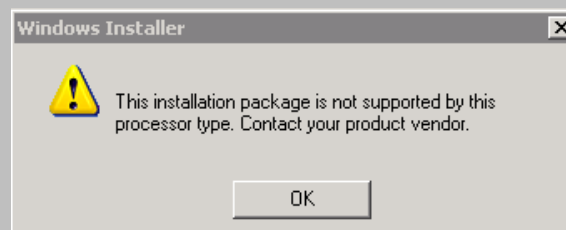

4.2.3 Extracting Files Without Running Installation

To extract the files without running installation, perform the following steps.

Step 1. Open a CMD console (Click Start-->Run and enter CMD).

Step 2. Enter the following command:

```
MLNX_VPI_WinOF-<version>_All_<OS>_<arch>.exe /a
```

Step 3. Click Next to create a server image.



Step 4. Click Change and specify the location in which the files are extracted to.



Step 5. Click Install to extract this folder, or click Change to install to a different folder.



Step 6. To complete the extraction, click Finish.



4.2.4 Installing MLNX_WinOF

This section provides instructions for two types of installation procedures:

- [“Attended Installation”](#)

An installation procedure that requires frequent user intervention.

- [“Unattended Installation”](#)

An automated installation procedure that requires no user intervention.



Both Attended and Unattended installations require administrator privileges.

4.2.4.1 Attended Installation

The following is an example of a MLNX_WinOF_win8 x64 installation session.

Step 1. Double click the .exe and follow the GUI instructions to install MLNX_WinOF.

To configure your setup to contain the logs option, please run the following command after opening a CMD console:

```
MLNX_VPI_WinOF-4_40_0_All_win8_x64.exe /v"/l*v* [LogFile] "
```

If you do not want to upgrade your firmware version, run the following command:

```
MLNX_VPI_WinOF-4_40_0_All_win8_x64.exe /v" MT_SKIPFWUPGRD=1 "
```

For further help, please run:

```
MLNX_VPI_WinOF-4_40_0_All_win8_x64.exe /v" /h"
```

Step 2. Click Next in the Welcome screen.



Step 3. Read then accept the license agreement and click Next.



Step 4. Select the target folder for the installation.



Step 5. The firmware upgrade screen will be displayed in the following cases:

- If the user has an OEM card, in this case the firmware will not be updated.

- If the user has a standard Mellanox card, and the firmware version is older than the one specified in WinOF Installation Guide 4.40, the firmware will be updated accordingly. However, if the user has both OEM card and Mellanox card, only Mellanox card will be updated.



Step 6. Configure your system for maximum performance by checking the maximum performance box.





This step requires rebooting your machine at the end of the installation.

Step 7. Select a Complete or Custom installation, follow Step a and on, on page 32.



- a. Select the desired feature to install:
- OpenSM - installs Windows OpenSM that is required to manage the subnet from a host. OpenSM is part of the driver and installed automatically.
 - Performance tools - install the performance tools that are used to measure the InfiniBand performance in user environment.
 - Analyze tools - install the tools that can be used either to diagnose or analyze the InfiniBand environment.
 - SDK - contains the libraries and DLLs for developing InfiniBand application over IBAL.
 - Documentation: contains the User Manual and Installation Guide.
 - ND FLTR DLLs: contains the files for standalone installation of the mlx4nd provider.



- b. Click Install to start the installation.



Step 8. Click Finish to complete the installation.



If the firmware upgrade fails, the following message will be displayed.



4.2.4.2 Unattended Installation

The following is an example of a MLNX_WinOF_win8 x64 unattended installation session.

Step 1. Open the CMD console (click Start > Run and enter 'cmd')

Step 2. Install the driver. Run:

```
> MLNX_VPI_WinOF-4_40_0_All_win8_x64.exe /S /v"/qn"
```

Step 3. [Optional] To configure your setup to contain the logs option, please run the following command:

```
> MLNX_VPI_WinOF-4_40_0_All_win8_x64.exe /S /v"/qn" /v"/l*vx [LogFile] "
```

Step 4. [Optional] If you do not want to upgrade your firmware version, run the following command:

```
> MLNX_VPI_WinOF-4_40_0_All_win8_x64.exe /S /v"/qn" /v" MT_SKIPFWUPGRD=1 "
```

For further help, please run:

```
> MLNX_VPI_WinOF-4_40_0_All_win8_x64.exe /v" /h"
```

4.2.5 Upgrading MLNX_WinOF

The MLNX_WinOF driver upgrades automatically MLNX_WinOF Windows 2008R2 driver by uninstalling the previous version and installs the new driver. However, MLNX_WinOF driver upgrade in Windows 2012 driver do not completely uninstall the previous version.

- In Windows 2012 (MLNX_WinOF Rev. 4.2 and above), the network configuration is saved upon driver upgrade.
- In Windows 2008 R2 the existing configuration files are not saved upon driver upgrade.

4.2.6 Installation Results

Upon installation completion, you can verify the successful addition of the network card(s) through the Device Manager. To see the Mellanox network adapter device, and the Ethernet or

IPoIB network device (depending on the used card) for each port, display the Device Manager and expand “System devices” or “Network adapters”.



4.2.7 OpenSM Activation

OpenSM is a service required by managed networks in InfiniBand environments, and must be activated in one of the machines running on the subnet, otherwise the interface link will not come up. If the cards are connected to a managed network, there is no need to run OpenSM. Only one OpenSM should run per subnet.

In Ethernet interfaces, running OpenSM is not required.

OpenSM does not run as a service during installation as it requires the GUID parameter to decide on which port to work. Setting OpenSM upon setup results in it working only for the first port and not for the others.

➤ **To run OpenSM as a service, assuming the package was installed in the default path, use:**

```
sc create OpenSM1 binPath= "c:\Program Files\Mellanox\MLNX_VPI\IB\Tools\
opensm.exe --service" start=auto"
```

➤ **To start the service, run:**

```
sc start opensm
```

For further information, please refer to the “OpenSM - Subnet Manager” chapter in the User Manual.

4.2.8 Uninstalling MLNX_WinOF

4.2.8.1 Attended Uninstall

➤ *To uninstall MLNX_WinOF on a single node, perform one of the following options:*

1. Click Start-> Control Panel-> Programs and Features-> MLNX_VPI-> Uninstall.
(NOTE: This requires elevated administrator privileges.)
2. Double click the .exe and follow the instructions of the install wizard.
3. Click Start-> All Programs-> Mellanox Technologies-> MLNX_WinOF-> Uninstall MLNX_WinOF.

4.2.8.2 Unattended Uninstall

➤ *To uninstall MLNX_WinOF in unattended mode, perform the following:*

Step 1. Open a CMD console.

Step 2. Uninstall the driver. Run:

```
MLNX_VPI_WinOF-4_40_0_All_win8_x64.exe /S /x /v"/qn"
```

4.2.9 Assigning Port IP After Installation

By default, your machine is configured to obtain an automatic IP address via a DHCP server. In some cases, the DHCP server may require the MAC address of the network adapter installed in your machine.

➤ *To obtain the MAC address:*

Step 1. Open a CMD console

Step 2. Display the MAC address as “Physical Address”

```
ipconfig /all
```

Configuring a static IP is the same for both IPoIB and Ethernet adapters.

➤ *To assign a static IP address to a network port after installation:*

Step 1. Open the Network Connections window. Locate Local Area Connections with Mellanox devices.



Step 2. Right-click a Mellanox Local Area Connection and left-click Properties.

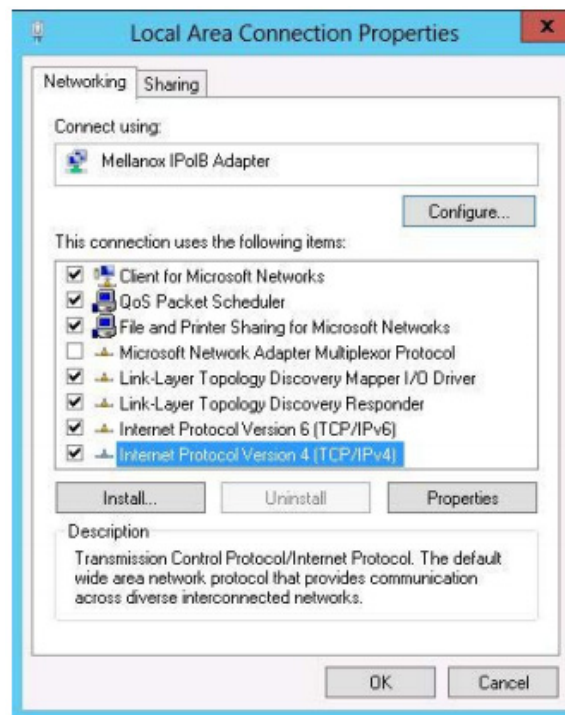

Step 3. Select Internet Protocol Version 4 (TCP/IPv4) from the scroll list and click Properties.

Step 4. Select the “Use the following IP address:” radio button and enter the desired IP information.



Step 5. Click OK.

Step 6. Close the Local Area Connection dialog.

Step 7. Verify the IP configuration by running ‘ipconfig’ from a CMD console.

```
> ipconfig
...
Ethernet adapter Local Area Connection 4:

    Connection-specific DNS Suffix  . :
    IP Address . . . . . : 11.4.12.63
    Subnet Mask . . . . . : 255.255.0.0
    Default Gateway . . . . . :
    ...
```

4.3 Performance Tuning

For guidelines on improving network adapter performance, please refer to the performance tuning guidelines for a Linux/Windows environment in the document http://www.mellanox.com/related-docs/prod_software/Performance_Tuning_Guide_for_Mellanox_Network_Adapters.pdf.

4.4 VMware Driver

For VMware download and install the latest Mellanox OFED Driver for VMware® ESXi Server-software package available via the Mellanox web site at: <http://www.mellanox.com> => Products => Software => Ethernet Drivers => VMware Drivers => Download. Follow the installation instructions included in the download package (also available from the download page).

4.4.1 Installing and Running the VBI Driver on ESXi-5.x

4. Log into the VMware ESXi server machine as root.
5. You can either:
 - a. Remove any earlier version of the driver from your VMware ESXi server machine prior to installing the new version. Run:

```
#> esxcli software vib list
#> esxcli software vib remove -n net-mlx4-en
```

- b. Install the mlx4_en driver VIB package. Run:

```
#> esxcli software vib install -v <vib_url>
```

- c. Reboot ESXi server (The driver will be loaded automatically).

OR

- a. Update the driver. Run:

```
#> esxcli software vib update -v <vib_url>
```

- b. Reboot ESXi server (The driver will be loaded automatically).

» *To verify that the driver is loaded, run:*

```
#> vmkload_mod -l | grep mlx4_en
```

» *To query network uplinks installed on your machine, run:*

```
#> esxcli network nic list
```

The number of uplinks claimed by MLX4_EN driver should be displayed.



In Non Multifunction Mode, port 2 is identified as a pseudo device. Therefore devices are not seen by vSphere when added as uplink.

For further information on how to manipulate the uplink, please refer to [Section 5.3, “Adding the Device as an uplink to an Existing Vswitch using the CLI,”](#) on page 10 of the VMware User Manual. See [Table 2, “Documents List,”](#) on page 9.

4.4.2 Installing and Running the offline_bundle Driver on ESXi-5.x

1. Copy the offline_bundle zip file to ESXi 5.0 machine and extract its contents.
2. You can install the driver in one of the following ways:
 - a. Remove any earlier version of the driver from your VMware ESXi server machine prior to installing the new version. Run:

```
#> esxcli software vib list
#> esxcli software vib remove -n net-mlx4-en
```

- b. . Install the mlx4_en driver offline_bundle package. Run:

```
#> esxcli software vib install -d
<path>/mlx4_en-mlnx-1.6.1.2-offline_bundle-471530.zip
```

- c. Reboot ESXi server. (The driver will be loaded automatically).

OR

- a. Update the driver. Run:

```
#> esxcli software vib update -n net-mlx4-en -d
<path>/mlx4_en-mlnx-1.6.1.2-offline_bundle-471530.zip
```

- b. Reboot ESXi server. (The driver will be loaded automatically).

» **To verify that the driver is loaded, run:**

```
#> vmkload_mod -l | grep mlx4_en
```

» **To query network uplinks installed on your machine, run:**

```
#> esxcli network nic list
```

The number of uplinks claimed by MLX4_EN driver should be displayed.



In Non Multifunction Mode, port 2 is identified as a pseudo device. Therefore devices are not seen by vSphere when added as uplink.

For further information on how to manipulate the uplink, please refer to [Section 5.3, “Adding the Device as an uplink to an Existing Vswitch using the CLI,”](#) on page 10 of the VMware User Manual. See [Table 2, “Documents List,”](#) on page 9.

4.4.3 Removing the VIB/offline_bundle Driver

» **To remove the VIB/offline_bundle driver package from the ESXi server machine, run:**

```
#> esxcli software vib remove -n net-mlx4-en
```

4.5 FlexBoot

FlexBoot supports remote Boot over Ethernet. This technology is based on the Preboot Execution Environment (PXE) standard specification, and FlexBoot software is based on the open source iPXE project (see www.ipxe.org). For more information go to <http://www.mellanox.com> => Products => Software => Ethernet Drivers => Download.

5 Updating Adapter Card Firmware

Each card is shipped with the latest version of qualified firmware at the time of manufacturing. However, Mellanox issues firmware updates occasionally and the most recent firmware can be obtained from: <http://www.mellanox.com> => Support. Check that the firmware on your card is the latest found on the Mellanox site, if not update to the latest version found on the Mellanox web site.

Firmware can be updated on the stand-alone single card using the **flint** tool of the *Mellanox Firmware Tools (MFT)* package. This package is available for download, along with its user manual, from the Mellanox Firmware Tools page. See <http://www.mellanox.com> => Software => Firmware Tools.

The following steps describe how to retrieve the PSID (firmware identification) and programmed firmware version of your adapter card. They also describe how to update the card with the latest firmware version available.

1. Retrieve the PSID and firmware version:
 - a. Install the MFT package. The package is available at <http://www.mellanox.com> => Products => Software => Firmware Tools. Make sure to download the package corresponding to your computer's operating system.
 - b. Enter: `mst start`.
 - c. Get the Mellanox *mst device name* using the command "`mst status`". The mst device name will be of the form: `/dev/mst/mt4099_pci_cr0`.
 - d. Get the PSID (firmware identification) and programmed firmware version using the command.

Note: The shown versions and/or parameter values in the example below may not reflect the latest or actual values for this product, and are included here for illustration purposes only.

```
flint -d /dev/mst/mt4099_pci_cr0 q
Image type:      ConnectX
FW Version:      2.30.4260
Device ID:       4099
Description:     Node          Port1          Port2
Sys image
GUIDs:           ffffffff ffffffff
ffffffffff ffffffff
MACs:            0002c9305350
0002c9305351
VSD:
PSID:           MT_1080120023
```

1. Compare the programmed firmware version with the latest available.
 - a. Go to Mellanox's web site: <http://www.mellanox.com/supportdownloader>. See Figure 11.
 - b. Enter your card PSID to display the latest firmware file. The file name of the binary is composed by combining the firmware name, the firmware release version, and the card part number.

Note: Please contact Mellanox System Support if you cannot find the firmware binary for your adapter card.

Figure 11: Support Download Assistant

Mellanox - Support Download Assistant

Support Index | Documentation Login | Customer Support | Returns | Home

CLEAR PSID or OPN Identifying Adapter Cards (PSID)

Browse for Product Support START OVER

Select a Family	Select a Line	Select an OPN	Select a PSID (Rev)	Product Support Information
Adapter Cards Switches Gateways	Select an item from previous column			

1. If a newer firmware version exists for your adapter card on the Web, update the firmware as follows:
 - a. Download the firmware (image) zip file from the Support Downloader (see Step 2a above).
 - b. Unzip the firmware image.
 - c. Burn the firmware image. Enter:

```
> flint -d /dev/mst/mt4099_pci_cr0 -i <binary image> burn
```

- a. Reboot the computer.
- b. Enter: mst start.
- c. Verify that the card firmware was updated successfully.

```
> flint -d /dev/mst/mt4099_pci_cr0 q
Image type:      ConnectX
FW Version:      2.9.4100
Device ID:       4099
...
```

6 Troubleshooting

6.1 General

GUID of ConnectX-3 Ethernet adapter cards	<ul style="list-style-type: none"> • Please use the GUID value returned by the fabric/driver utilities (not 0xfffff). See Appendix B.1, “Retrieving Adapter Card GUID,” on page 59.
Server unable to find the adapter	<ul style="list-style-type: none"> • Ensure that the adapter is placed correctly • Make sure the adapter slot and the adapter are compatible • Install the adapter in a different PCI Express slot • Use the drivers that came with the adapter or download the latest • Make sure your motherboard has the latest BIOS • Try to reboot the server
The adapter no longer works	<ul style="list-style-type: none"> • Reseat the adapter in its slot or a different slot, if necessary • Try using another cable • Reinstall the drivers for the network driver files may be damaged or deleted • Reboot the server
Adapters stopped working after installing another adapter	<ul style="list-style-type: none"> • Try removing and re-installing all adapters • Check that cables are connected properly • Make sure your motherboard has the latest BIOS
Link indicator light is off	<ul style="list-style-type: none"> • Ensure that adapter driver/s is loaded • Try another port on the switch • Make sure the cable is securely attached • Check your are using the proper cables that do not exceed the recommended lengths • Verify that your switch and adapter port are compatible
Link light is on, but with no communication established	<ul style="list-style-type: none"> • Check that the latest driver is loaded • Check that both the adapter and its link are set to the same speed and duplex settings

6.2 Linux

Environment Information	<pre>cat/etc/issue uname -a cat/proc/cupinfo grep 'model name' uniq ofed_info head -1 ifconfig -a ethtool <interface> ethtool -i <interface_of_Mellanox_port_num> ibdev2netdev</pre>
Card Detection	<pre>lspci grep -i Mellanox</pre>
Mellanox Firmware Tool (MFT)	<p>Download and install MFT: http://www.mellanox.com/content/pages.php?pg=management_tools&menu_section=34 Refer to the User Manual for installation instructions.</p> <p>Once installed, run:</p> <pre>mst start mst status flint -d <mst_device> q</pre>
Ports Information	<pre>ibstat lsv_devinfo</pre>
Firmware Version Upgrade	<p>To download the latest firmware version refer to http://www.mellanox.com/supportdownloader</p>
Collect Log File	<pre>/var/log/messages dmesg > system.logF</pre>

6.3 Windows

Environment Information	<p>From the Windows desktop choose the Start menu and run: msinfo32 To export system information to a text file, choose the Export option from the File menu. Assign a file name and save.</p>
Mellanox Firmware Tool (MFT)	<p>Download and install MFT: http://www.mellanox.com/content/pages.php?pg=management_tools&menu_section=34 Refer to the User Manual for installation instructions.</p> <p>Once installed, open a CMD window and run: cd C:\Program Files\Mellanox\WinMFT mst start mst status flint -d <mst_device> q</p>
Ports Information	vstat
Firmware Version Upgrade	<p>Download the latest firmware version using the PSID/board ID: http://www.mellanox.com/supportdownloader/ flint -d <mst_device> -i <firmware_bin_file> b</p>
Collect log file	<ul style="list-style-type: none"> • Event log viewer • MST device logs: <ul style="list-style-type: none"> • mst start • mst status • C:\Users\Administrator> flint -d <mst_device> dc > dump_configuration.log • C:\Users\Administrator> mstdump <mst_device> dc > mstdump.log

7 Specifications

7.1 MCX311A-XCAT Specifications

Table 7 - MCX311A-XCAT Specifications Table

Physical	Size: 2.11in. x 4.18 in. (53.59mm x 106.06 mm)
	Connector: SFP+ 10Gb/s
Protocol Support	Ethernet: XAUI/10GBASE-KX4 – 4X 10GigE port, XFI/SFI/10GBASE-KR – 1X 10GigE port, SGMII/1000BASE-KX – 1X 1GigE port
	Data Rate: 1/10Gb/s – Ethernet
	PCI Express Gen3: SERDES @ 8.0GT/s, 4 lanes (2.0 and 1.1 compatible)
Power and Environmental	Voltage: 12V, 3.3V
	Typ Power: Passive Cables 3.47W
	Max Power: Passive Cables 4.84W
	Max power available through SFP+ port: 1W
	Temperature: Operational 0°C to 55°C Non-operational 0°C to 70°C
	Humidity: 90% relative humidity ^a
	Air Flow: 200LFM ^b
Regulatory	EMC: Refer to the following link: www.mellanox.com/related-docs/user_manuals/Regulatory_and_Compliance_Guide.pdf
	Safety: IEC/EN 60950-1:2006 ETSI EN 300 019-2-2 IEC 60068-2- 64, 29, 32
	RoHS: RoHS-R6
Cable Support	Please refer to www.mellanox.com => Products => Cables and Transceivers

a. For both operational and non-operational states

b. Air flow is measured ~1” from the heat sink between the heat sink and the cooling air inlet.

7.2 MCX312[AB]A-XCBT Specifications

Table 8 - MCX312[AB]-XCBT Specifications Table

Physical	Size: For <i>MXC312A-XCBT</i> - 2.71in. x 5.6in. (68.90 mm x 142.24 mm) For <i>MCX312B-XCBT</i> - 2.11in x 5.6in (53.59mm x 142.24mm)
	Connector: SFP+ 10Gb/s
Protocol Support	Ethernet: 10GBASE-CX4, 10GBASE-R, and 1000BASE-R
	Data Rate: 1/10Gb/s – Ethernet
	PCI Express Gen3: SERDES @ 8.0GT/s, 4 lanes (2.0 and 1.1 compatible) PCI Express Gen2: SERDES @ 5.0GT/s, 8 lanes (1.1 compatible)
Power and Environmental	Voltage: 12V, 3.3V
	Typ Power: PCIe x4 Gen3 Passive Cables 3.83W PCIe x8 Gen2 Passive Cables 5.31W
	Max Power: PCIe x4 Gen3 Passive Cables 4.55W PCIe x8 Gen2 Passive Cables 6.20W
	Max power available through SFP+ port: 1W
	Temperature: Operational 0°C to 55°C Non-operational 0°C to 70°C
	Humidity: 90% relative humidity ^a
	Air Flow: 200LFM ^b
	EMC: Refer to the following link: www.mellanox.com/related-docs/user_manuals/Regulatory_and_Compliance_Guide.pdf
Regulatory	Safety: IEC/EN 60950-1:2006 ETSI EN 300 019-2-2 IEC 60068-2- 64, 29, 32
	RoHS: RoHS-R6
Cable Support	Please refer to www.mellanox.com => Products => Cables and Transceivers

a. For both operational and non-operational states

b. Air flow is measured ~1” from the heat sink between the heat sink and the cooling air inlet.

7.3 Adapter LED Operation

There are two I/O LEDs per port in dual-port designs and one bicolor LED in single-port designs, green and yellow, located on the I/O panel. See [Table 9](#) for different LED functions.

Table 9 - Physical and Logical Link Indication

LED	Function
Green - physical link	<ul style="list-style-type: none">• Constant on indicates a good physical link• If neither LED is lit, then the physical link has not been established
Yellow - logical (data activity link)	<ul style="list-style-type: none">• A blinking yellow indicates activity (data transfer)• Stays off when there is no activity



The short bracket has the same port and LED footprints as the tall bracket.

7.4 Board Mechanical Drawing and Dimensions



All dimensions are in millimeters.
All the mechanical tolerances are $\pm 0.1\text{mm}$.

Figure 12: Mechanical Drawing of the Single-port MCX311A-XCAT Adapter Card

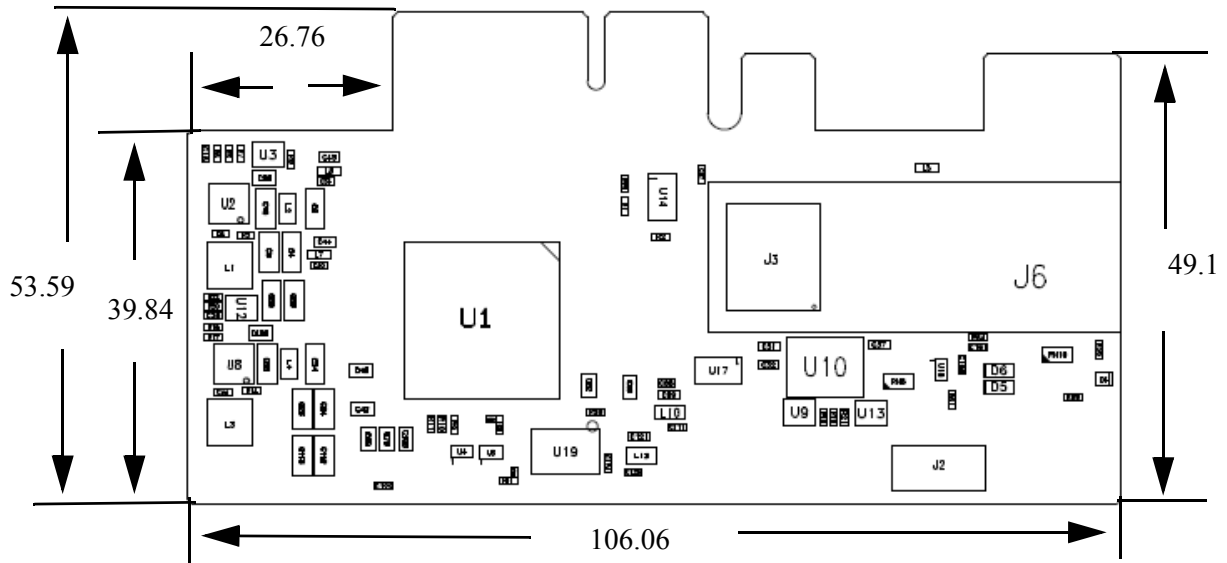

Figure 13: Mechanical Drawing of the Dual-port MCX312A-XCBT Adapter Card

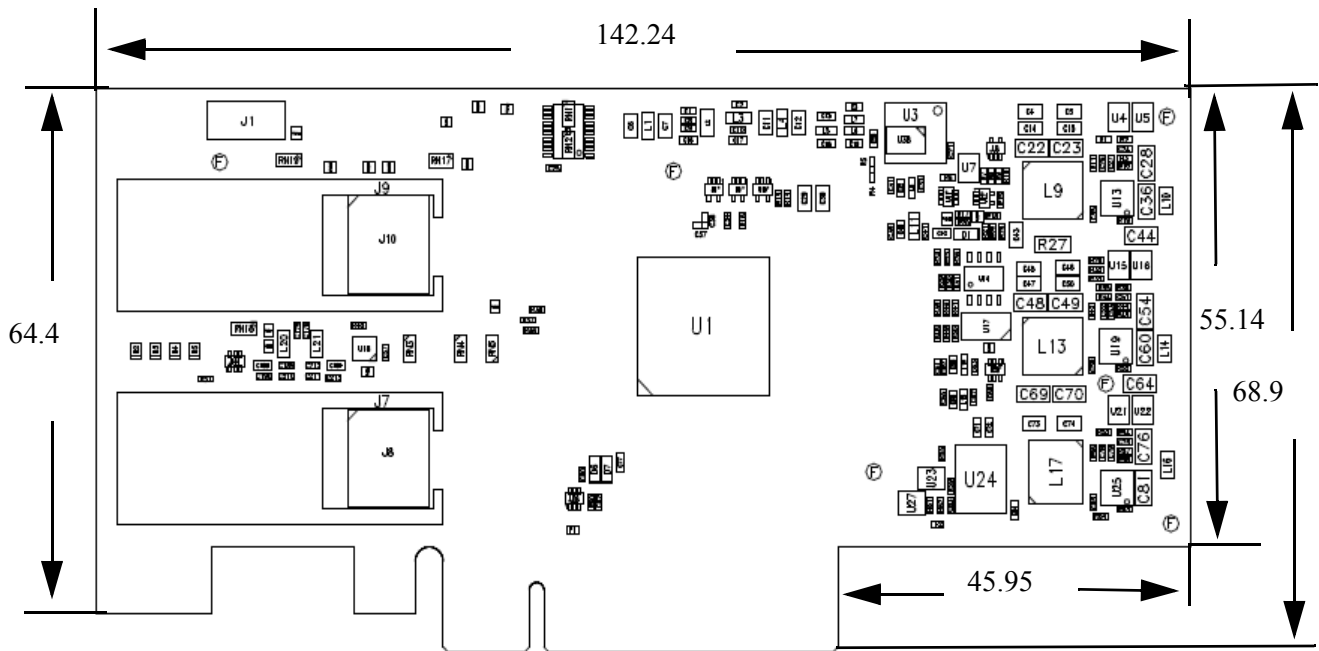
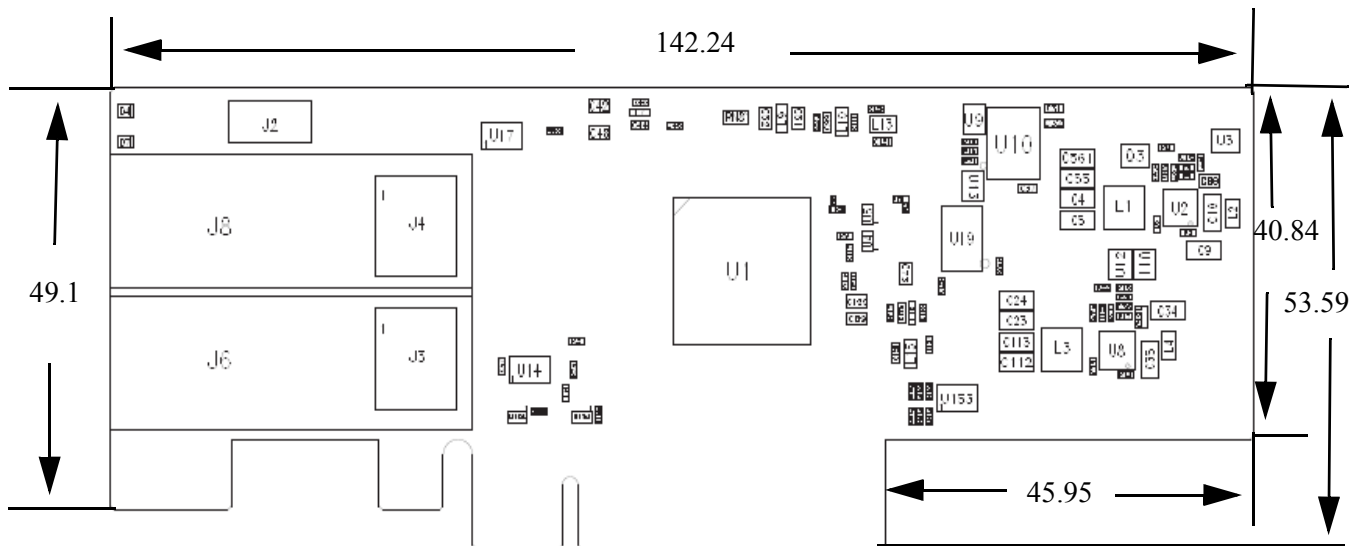

Figure 14: Mechanical Drawing of the Dual-port MCX312B-XCBT



7.5 Bracket Mechanical Drawing

Figure 15: Dual-port Bracket for MCX312A-XCBT

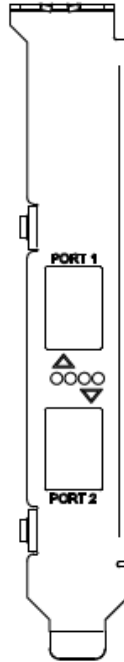

Figure 16: Dual-port Bracket for MCX312B-XCBT

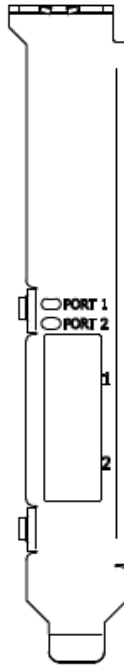
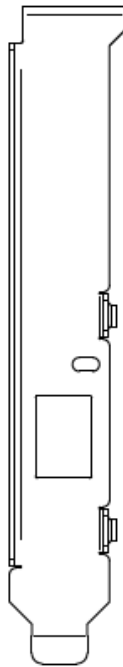

Figure 17: Single-port Bracket



7.6 Regulatory Statements

For regulatory statements for all ConnectX®-3 cards please refer to:

http://www.mellanox.com/related-docs/user_manuals/Regulatory_and_Compliance_Guide.pdf

Appendix A: Interface Connectors Pinout

A.1 SFP+ Connector Pinout

Figure 18: Rear View of Module With Pin Placement

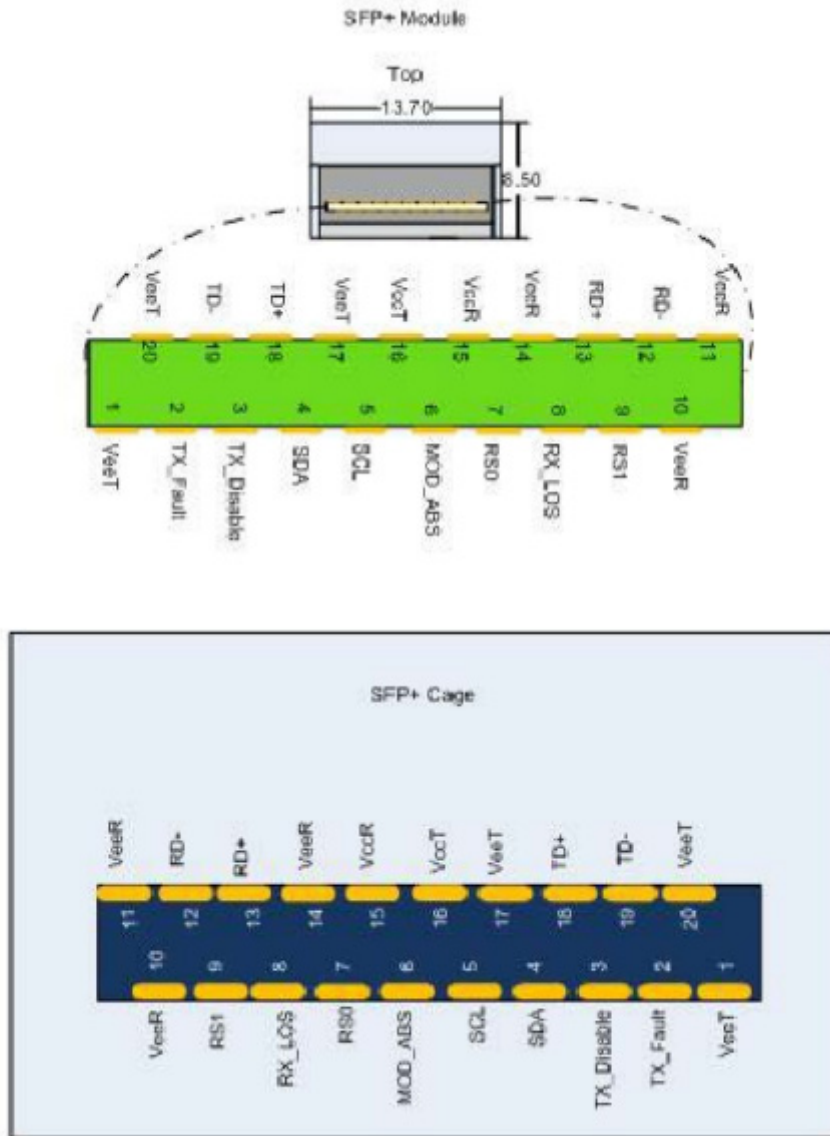

Table 10 - SFP+ Connector Pinout

Pin	Symbol Name	Description
1	VeeT	Transmitter Ground (Common with Receiver Ground) ^a
2	TX_Fault	Transmitter Fault. ^b
3	TX_Disable	Transmitter Disable. Laser output disabled on high or open. ^c
4	SDA	2-wire Serial Interface Data Line ^d
5	SCL	2-wire Serial Interface Clock Line ^d
6	MOD_ABS	Module Absent. Grounded within the module ^d
7	RS0	No connection required
8	RX_LOS	Loss of Signal indication. Logic 0 indicates normal operation. ^e
9	RS1	No connection required
10	VeeR	Receiver Ground (Common with Transmitter Ground) ^a
11	VeeR	Receiver Ground (Common with Transmitter Ground) ^a
12	RD-	Receiver Inverted DATA out. AC Coupled
13	RD+	Receiver Non-inverted DATA out. AC Coupled
14	VeeR	Receiver Ground (Common with Transmitter Ground) ^a
15	VccR	Receiver Power Supply
16	VccT	Transmitter Power Supply
17	VeeT	Transmitter Ground (Common with Receiver Ground) ^a
18	TD+	Transmitter Non-Inverted DATA in. AC Coupled.
19	TD-	Transmitter Inverted DATA in. AC Coupled.
20	VeeT	Transmitter Ground (Common with Receiver Ground) ^a

- a. Circuit ground is internally isolated from chassis ground.
- b. T_{FAULT} is an open collector/drain output, which should be pulled up with a 4.7k – 10k Ohms resistor on the host board if intended for use. Pull up voltage should be between 2.0V to $V_{\text{cc}} + 0.3\text{V}$. A high output indicates a transmitter fault caused by either the TX bias current or the TX output power exceeding the preset alarm thresholds. A low output indicates normal operation. In the low state, the output is pulled to <0.8V.
- c. Laser output disabled on $\text{TDIS} > 2.0\text{V}$ or open, enabled on $\text{TDIS} < 0.8\text{V}$
- d. Should be pulled up with 4.7k Ω – 10k Ω on host board to a voltage between 2.0V and 3.6V. MOD_ABS pulls line low to indicate module is plugged in.
- e. LOS is open collector output. Should be pulled up with 4.7k Ω – 10k Ω on host board to a voltage between 2.0V and 3.6V. Logic 0 indicates normal operation; logic 1 indicates loss of signal.

A.2 PCI Express x8 Connector Pinout

The adapter cards use a standard PCI Express x4 or x8 edge connector and the PCI Express x8 standard pinout according to the PCI Express 3.0 specification.

Figure 19: PCIe Connector Pinout

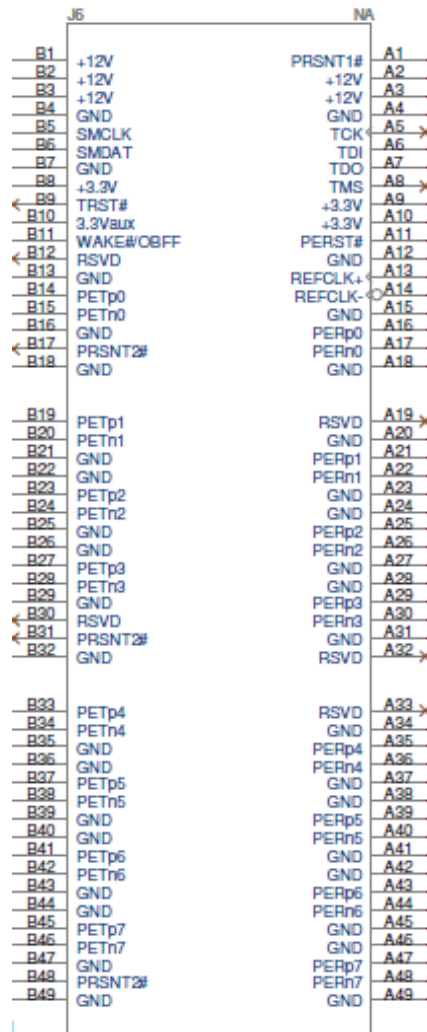

A.3 I²C-compatible Connector Pinout

Figure 20: Compatible Connector Plug and Pinout

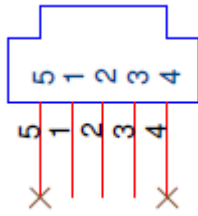

Connector Pin Number	Signal Name
1	SPSDA
2	SPSCL
3	GND
4	NC
5	NC

Appendix B: Finding the GUID/ MAC and Serial Number on the Adapter Card

Each Mellanox adapter card has a different identifier printed on the label: serial number and the card MAC for the Ethernet protocol.

Figure 21: Card Product Label (Example)

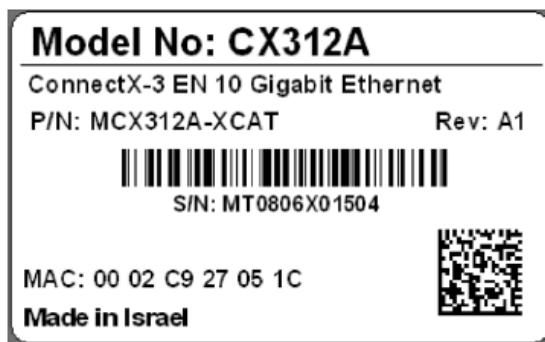

Figure 22: Board Labels for MCX312B-XCBT



B.1 Retrieving Adapter Card GUID

On ConnectX-3 Ethernet adapter cards, there is a mismatch between the GUID value returned by firmware management tools and that returned by fabric/driver utilities that read the GUID via device firmware (e.g., using `ibstat`). `Mlxburn/flint` returns `0xffff` as GUID while the utilities return a value derived from the MAC address. For all driver/firmware/software purposes, the latter value should be used. Please see the below example.

```

ibstat
CA 'mlx4_0'
  CA type: MT4099
  Number of ports: 2
  Firmware version: 2.30.4260
  Hardware version: 1
  Node GUID: 0x0002c90300305350
  System image GUID: 0x0002c90300305350
  Port 1:
    State: Down
    Physical state: Disabled
    Rate: 10
    Base lid: 0
    LMC: 0
    SM lid: 0
    Capability mask: 0x00010000
    Port GUID: 0x0202c9fffe305350
    Link layer: Ethernet
  Port 2:
    State: Down
    Physical state: Disabled
    Rate: 10
    Base lid: 0
    LMC: 0
    SM lid: 0
    Capability mask: 0x00010000
    Port GUID: 0x0202c9fffe305351
    Link layer: Ethernet

```

```

flint -d /dev/mst/mt4099_pci_cr0 q
Image type:      ConnectX
FW Version:     2.30.4260
Device ID:      4099
Description:    Node          Port1          Port2          Sys image
GUIDs:         ffffffff ffffffff ffffffff ffffffff
ffffffffff
MACs:          0002c9305350 0002c9305351
VSD:
PSID:          MT_1080120023

```

Appendix C: Safety Warnings

1. Installation Instructions



Read all installation instructions before connecting the equipment to the power source.

2. Over-temperature



This equipment should not be operated in an area with an ambient temperature exceeding the maximum recommended: 55°C (131°F).

To guarantee proper air flow, allow at least 8cm (3 inches) of clearance around the ventilation openings.

3. During Lightning - Electrical Hazard



During periods of lightning activity, do not work on the equipment or connect or disconnect cables.

4. Copper Cable Connecting/Disconnecting



Some copper cables are heavy and not flexible, as such they should be carefully attached to or detached from the connectors. Refer to the cable manufacturer for special warnings and instructions.

5. Equipment Installation



This equipment should be installed, replaced, or serviced only by trained and qualified personnel.

6. Equipment Disposal



Disposal of this equipment should be in accordance to all national laws and regulations.

7. Local and National Electrical Codes



This equipment should be installed in compliance with local and national electrical codes.

8. Hazardous Radiation Exposure



Caution – Use of controls or adjustment or performance of procedures other than those specified herein may result in hazardous radiation exposure.



CLASS 1 LASER PRODUCT and reference to the most recent laser standards:
IEC 60 825-1:1993 + A1:1997 + A2:2001 and EN 60825-1:1994+A1:1996+
A2:20.

Appendix D: Avertissements de sécurité d'installation (Warnings in French)

1. Instructions d'installation



Lisez toutes les instructions d'installation avant de brancher le matériel à la source d'alimentation électrique.

2. Température excessive



Ce matériel ne doit pas fonctionner dans une zone avec une température ambiante dépassant le maximum recommandé de 55°C (131°F). Un flux d'air de 200LFM à cette température ambiante maximale est nécessaire. En outre, pour garantir un bon écoulement de l'air, laissez au moins 8 cm (3 pouces) d'espace libre autour des ouvertures de ventilation.

3. Orages – dangers électriques



Pendant un orage, il ne faut pas utiliser le matériel et il ne faut pas brancher ou débrancher les câbles.

4. Branchement/débranchement des câbles en cuivre



Les câbles en cuivre sont lourds et ne sont pas flexibles, il faut donc faire très attention en les branchant et en les débranchant des connecteurs. Consultez le fabricant des câbles pour connaître les mises en garde et les instructions spéciales.

5. Installation du matériel



Ce matériel ne doit être installé, remplacé ou entretenu que par du personnel formé et qualifié.

6. Élimination du matériel



L'élimination de ce matériel doit s'effectuer dans le respect de toutes les législations et réglementations nationales en vigueur.

7. Codes électriques locaux et nationaux



Ce matériel doit être installé dans le respect des codes électriques locaux et nationaux.

8. Exposition au rayonnement grave



Mise en garde – l'utilisation de commandes ou de réglages ou l'exécution de procédures autres que ce qui est spécifié dans les présentes peut engendrer une exposition au rayonnement grave.



PRODUIT LASER DE CLASSE 1 » et références aux normes laser les plus récentes CEI 60 825-1:1993 + A1:1997 + A2:2001 et NE 60825-1:1994+A1:1996+ A2:2001

Appendix E: Sicherheitshinweise (Warnings in German)

1. Installationsanleitungen



Lesen Sie alle Installationsanleitungen, bevor Sie das Gerät an die Stromversorgung anschließen.

2. Übertemperatur



Dieses Gerät sollte nicht in einem Bereich mit einer Umgebungstemperatur über der maximal empfohlenen Temperatur von 55°C (131°F) betrieben werden. Es ist ein Luftstrom von 200 LFM bei maximaler Umgebungstemperatur erforderlich. Außerdem sollten mindestens 8 cm (3 in.) Freiraum um die Belüftungsöffnungen sein, um einen einwandfreien Luftstrom zu gewährleisten.

3. Bei Gewitter - Elektrische Gefahr



Arbeiten Sie während eines Gewitters und Blitzschlag nicht am Gerät, schließen Sie keine Kabel an oder ab.

4. Anschließen/Trennen von -Kupferkabel



Kupferkabel sind schwer und nicht flexible. Deshalb müssen sie vorsichtig an die Anschlüsse angebracht bzw. davon getrennt werden. Lesen Sie die speziellen Warnungen und Anleitungen des Kabelherstellers.

5. Geräteinstallation



Diese Gerät sollte nur von geschultem und qualifiziertem Personal installiert, ausgetauscht oder gewartet werden.

6. Geräteentsorgung



Die Entsorgung dieses Geräts sollte unter Beachtung aller nationalen Gesetze Bestimmungen erfolgen.

7. Regionale und nationale elektrische Bestimmungen



Dieses Gerät sollte unter Beachtung der regionalen und nationalen elektrischen Bestimmungen installiert werden.



This equipment should be installed in compliance with local and national electrical codes.

8. Strahlenkontakt



Achtung – Nutzung von Steuerungen oder Einstellungen oder Ausführung von Prozeduren, die hier nicht spezifiziert sind, kann zu gefährlichem Strahlenkontakt führen..



Klasse 1 Laserprodukt und Referenzen zu den aktuellsten Lasterstandards :
ICE 60 825-1:1993 + A1:1997 + A2:2001 und EN 60825-1:1994+A1:1996+A2:2001

Appendix F: Advertencias de seguridad para la instalación (Warnings in Spanish)

1. Instrucciones de instalación



Antes de conectar el equipo a la fuente de alimentación, leer todas las instrucciones de instalación.

2. Sobrecalentamiento



No se debe utilizar el equipo en un área con una temperatura ambiente superior a la máxima recomendada: 55°C(131°F). Además, para garantizar una circulación de aire adecuada, se debe dejar como mínimo un espacio de 8 cm (3 pulgadas) alrededor de las aberturas de ventilación.

3. Cuando hay rayos: peligro de descarga eléctrica



No utilizar el equipo ni conectar o desconectar cables durante períodos de actividad de rayos.

4. Conexión y desconexión del cable Copper



Dado que los cables de cobre son pesados y no son flexibles, su conexión a los conectores y su desconexión se deben efectuar con mucho cuidado. Para ver advertencias o instrucciones especiales, consultar al fabricante del cable.

5. Instalación de equipos



La instalación, el reemplazo y el mantenimiento de este equipo estarán a cargo únicamente de personal capacitado y competente.

6. Eliminación de equipos



La eliminación definitiva de este equipo se debe efectuar conforme a todas las leyes y reglamentaciones nacionales.

7. Códigos eléctricos locales y nacionales



Este equipo se debe instalar conforme a los códigos eléctricos locales y nacionales.

8. Exposición a niveles de radiación peligrosos



Precaución: el uso de controles o ajustes o la realización de procedimientos distintos de los que aquí se especifican podrían causar exposición a niveles de radiación peligrosos.



PRODUCTO LÁSER DE CLASE 1 y referencia a las normas de láser más recientes:
IEC 60825-1:2007/03 y EN 60825-1:2007