



ConnectX[®]-3 Pro 10Gb/s Ethernet Single and Dual SFP+ Port Network Interface Card User Manual for Open Compute Project

P/N:

MCX341A-XCPN, MCX342A-XCPN, MCX341A-XCQN, MCX342A-XCQN

Rev 1.1

NOTE:

THIS HARDWARE, SOFTWARE OR TEST SUITE PRODUCT (“PRODUCT(S)”) AND ITS RELATED DOCUMENTATION ARE PROVIDED BY MELLANOX TECHNOLOGIES “AS-IS” WITH ALL FAULTS OF ANY KIND AND SOLELY FOR THE PURPOSE OF AIDING THE CUSTOMER IN TESTING APPLICATIONS THAT USE THE PRODUCTS IN DESIGNATED SOLUTIONS. THE CUSTOMER’S MANUFACTURING TEST ENVIRONMENT HAS NOT MET THE STANDARDS SET BY MELLANOX TECHNOLOGIES TO FULLY QUALIFY THE PRODUCT(S) AND/OR THE SYSTEM USING IT. THEREFORE, MELLANOX TECHNOLOGIES CANNOT AND DOES NOT GUARANTEE OR WARRANT THAT THE PRODUCTS WILL OPERATE WITH THE HIGHEST QUALITY. ANY EXPRESS OR IMPLIED WARRANTIES, INCLUDING, BUT NOT LIMITED TO, THE IMPLIED WARRANTIES OF MERCHANTABILITY, FITNESS FOR A PARTICULAR PURPOSE AND NONINFRINGEMENT ARE DISCLAIMED. IN NO EVENT SHALL MELLANOX BE LIABLE TO CUSTOMER OR ANY THIRD PARTIES FOR ANY DIRECT, INDIRECT, SPECIAL, EXEMPLARY, OR CONSEQUENTIAL DAMAGES OF ANY KIND (INCLUDING, BUT NOT LIMITED TO, PAYMENT FOR PROCUREMENT OF SUBSTITUTE GOODS OR SERVICES; LOSS OF USE, DATA, OR PROFITS; OR BUSINESS INTERRUPTION) HOWEVER CAUSED AND ON ANY THEORY OF LIABILITY, WHETHER IN CONTRACT, STRICT LIABILITY, OR TORT (INCLUDING NEGLIGENCE OR OTHERWISE) ARISING IN ANY WAY FROM THE USE OF THE PRODUCT(S) AND RELATED DOCUMENTATION EVEN IF ADVISED OF THE POSSIBILITY OF SUCH DAMAGE.



Mellanox Technologies
 350 Oakmead Parkway Suite 100
 Sunnyvale, CA 94085
 U.S.A.
www.mellanox.com
 Tel: (408) 970-3400
 Fax: (408) 970-3403

© Copyright 2016. Mellanox Technologies. All Rights Reserved.

Mellanox®, Mellanox logo, BridgeX®, CloudX logo, Connect-IB®, ConnectX®, CoolBox®, CORE-Direct®, GPUDirect®, InfiniHost®, InfiniScale®, Kotura®, Kotura logo, Mellanox Federal Systems®, Mellanox Open Ethernet®, Mellanox ScalableHPC®, Mellanox Connect Accelerate Outperform logo, Mellanox Virtual Modular Switch®, MetroDX®, MetroX®, MLNX-OS®, Open Ethernet logo, PhyX®, SwitchX®, TestX®, The Generation of Open Ethernet logo, UFM®, Virtual Protocol Interconnect®, Voltaire® and Voltaire logo are registered trademarks of Mellanox Technologies, Ltd.

Accelio™, CyPU™, FPGADirect™, HPC-X™, InfiniBridge™, LinkX™, Mellanox Care™, Mellanox CloudX™, Mellanox Multi-Host™, Mellanox NEO™, Mellanox PeerDirect™, Mellanox Socket Direct™, Mellanox Spectrum™, NVMeDirect™, StPU™, Spectrum logo, Switch-IB™, Unbreakable-Link™ are trademarks of Mellanox Technologies, Ltd.

All other trademarks are property of their respective owners.

Table of Contents

Table of Contents	3
List of Figures	5
List of Tables	6
Revision History	7
About this Manual	8
Chapter 1 Introduction	10
1.1 Product Overview	10
1.2 Features and Benefits	11
1.3 Operating Systems/Distributions	12
1.4 Connectivity	12
Chapter 2 Interfaces	13
2.1 Ethernet Interface	13
2.2 PCI Express Interface	13
2.3 I2C-compatible Interface	13
2.4 LED Interface	14
2.5 Network Controller Sideband Interface (NC-SI)	14
Chapter 3 Hardware Installation	15
3.1 System Requirements	15
3.1.1 Hardware	15
3.1.2 Operating Systems/Distributions	15
3.1.3 Software Stacks	15
3.2 Safety Precautions	15
3.3 Pre-installation Checklist	15
3.4 Card Installation Instructions	15
3.5 Cables and Modules	16
3.6 Identify the Card in Your System	16
3.6.1 On Windows	16
3.6.2 On Linux	17
Chapter 4 Driver Installation	18
4.1 Linux Driver	18
4.1.1 Hardware and Software Requirements	18
4.1.2 Installing the Driver	18
4.1.3 Loading the Driver	19
4.1.4 Unloading the Driver	19
4.1.5 Uninstalling the Driver	19
4.2 Windows Driver	20
4.2.1 Hardware and Software Requirements	20
4.2.2 Downloading MLNX_WinOF	20
4.2.3 Extracting Files Without Running Installation	21
4.2.4 Installing MLNX_WinOF	22
4.2.4.1 Attended Installation	23
4.2.4.2 Unattended Installation	28
4.2.5 Upgrading MLNX_WinOF	29
4.2.6 Installation Results	29
4.2.7 OpenSM Activation	30
4.2.8 Uninstalling MLNX_WinOF	31
4.2.8.1 Attended Uninstall	31
4.2.8.2 Unattended Uninstall	31

4.2.9	Assigning Port IP After Installation	31
4.3	VMware Driver	32
4.3.1	Installing and Running the VBI Driver on ESXi-5.x	33
4.3.2	Installing and Running the offline_bundle Driver on ESXi-5.x	33
4.3.3	Removing the VIB/offline_bundle Driver	34
4.4	FlexBoot	34
Chapter 5	Updating Card Firmware	35
Chapter 6	Troubleshooting	37
6.1	General	37
6.2	Linux	38
6.3	Windows	39
Chapter 7	Specifications	40
7.1	MCX341A-XC[P/Q]N Specifications	40
7.2	MCX342A-XC[P/Q]N Specifications	41
7.3	Board Mechanical Drawing and Dimensions	42
7.4	Adapter LED Operation	43
Appendix A	Finding the MAC and Serial Number on the Card	44
A.1	Retrieving Card GUID	46
Appendix B	Interface Connectors Pinout	48
B.1	PCI Express x8 Connector Pinout	48
B.2	I2C-compatible Connector Pinout	49
B.3	NC-SI Interface Pinout	49
Appendix C	Safety Warnings	50
Appendix D	Avertissements de sécurité d'installation (Warnings in French)	52
Appendix E	Sicherheitshinweise (Warnings in German)	54
Appendix F	Advertencias de seguridad para la instalación (Warnings in Spanish)	56

List of Figures

Figure 1:	I2C Harness	13
Figure 2:	PCI Device (Example)	16
Figure 3:	Support Download Assistant	36
Figure 4:	Mechanical Drawing of the Single-port MCX341A Mezzanine Card	42
Figure 5:	Mechanical Drawing of the Dual-port MCX342A Mezzanine Card	43
Figure 6:	MCX341A-XCPN Board Label (Example only - see <i>Note</i>)	44
Figure 7:	MCX341A-XCQN Board Label (Example only - see <i>Note</i>)	45
Figure 8:	MCX342A-XCPN Board Label (Example only - see <i>Note</i>)	45
Figure 9:	MCX342A-XCQN Board Label (Example only - see <i>Note</i>)	46
Figure 10:	PCIe Connector Pinout	48
Figure 11:	Compatible Connector Plug and Pinout	49
Figure 12:	NC-SI Interface Pinout	49

List of Tables

Table 1:	Revision History Table	7
Table 2:	Documents List	10
Table 3:	Single and Dual-port 10 Gigabit Ethernet Network Interface Cards.	10
Table 4:	Features	11
Table 5:	Software and Hardware Requirements	18
Table 6:	Software and Hardware Requirements	20
Table 7:	MCX341A-XC[P/Q]N Specifications Table.	40
Table 8:	MCX342A-XC[P/Q]N Specifications Table.	41
Table 9:	Physical and Logical Link Indication	43
Table 10:	I2C-compatible Connector Pinout.	49

Revision History

This document was printed on January 17, 2016.

Table 1 - Revision History Table

Date	Rev	Comments/Changes
January 2016	1.1	Updated Section 3.4, “Card Installation Instructions,” on page 15.
January 2015	1.0	First Release

About this Manual

This *User Manual* describes Mellanox Technologies ConnectX®-3 Pro 10 Gigabit Ethernet Single and Dual SFP+ Port PCI Express x8 network interface cards. It provides details as to the interfaces of the board, specifications, required software and firmware for operating the board, and relevant documentation.

Intended Audience

This manual is intended for the installer and user of these cards.

The manual assumes basic familiarity with Ethernet networks and architecture specifications.

Related Documentation

Table 2 - Documents List

<i>Mellanox Firmware Tools (MFT) User Manual</i> Document no. 2204UG	User Manual describing the set of MFT firmware management tools for a single node. See http://www.mellanox.com => Products => Software => Firmware Tools
<i>MLNX_EN for Linux README Driver Kit for Mellanox Adapter Cards with 10GigE Support</i> Document no. 2950	This document provides information on the MLNX_EN Linux driver and instructions for installing the driver on Mellanox ConnectX adapter cards supporting 10Gb/s Ethernet.
<i>Mellanox OFED for Linux User Manual</i> Document no. 2877	User Manual describing OFED features, performance, InfiniBand diagnostic, tools content and configuration. See http://www.mellanox.com => Products => Software => Linux SW/Drivers => Mellanox OpenFabrics Enterprise Distribution for Linux (MLNX_OFED)
<i>WinOF VPI for Windows User Manual</i> Document no. 3280	User Manual describing WinOF features, performance, InfiniBand diagnostic, tools content and configuration. See http://www.mellanox.com => Products => Software => Windows SW/Drivers => Mellanox OFED for Windows (WinOF)
<i>Mellanox MLX4_EN Driver for VMware README</i> Document no. 3527	User Manual describing MLX4_EN driver for VMware features, performance, diagnostic, tools content and configuration. See http://www.mellanox.com => Products => Software => Ethernet Drivers => VMware Drivers
<i>IEEE Std 802.3 Specification</i>	This is the IEEE Ethernet specification http://standards.ieee.org/getieee802
PCI Express 3.0 Specifications	Industry Standard PCI Express 3.0 Base and Card Electromechanical Specifications

Online Resources

- Mellanox Technologies web pages: <http://www.mellanox.com>
- Mellanox Technologies Firmware download web page:
<http://www.mellanox.com> => Support => Download Center

Document Conventions

When discussing memory sizes, MB and MBytes are used in this document to mean size in mega bytes. The use of Mb or Mbits (small b) indicates size in mega bits.

Technical Support

Customers who purchased Mellanox products directly from Mellanox are invited to contact us through the following methods.

- URL: <http://www.mellanox.com> => Support
- E-mail: support@mellanox.com
- Tel: +1.408.916.0055

Customers who purchased Mellanox M-1 Global Support Services, please see your contract for details regarding Technical Support.

Customers who purchased Mellanox products through a Mellanox approved reseller should first seek assistance through their reseller.

Firmware and Software Updates

The Mellanox support downloader contains software, firmware and knowledge database information for Mellanox products. Access the data base from the Mellanox Support web page,

<http://www.mellanox.com> => Support

or use the following link to go directly to the Mellanox Support Download Assistant page,

<http://www.mellanox.com/supportdownloader/>.

1 Introduction

This is the User Guide for Mellanox Technologies Ethernet network interface cards based on the ConnectX®-3 Pro EN integrated circuit device for Open Compute Project (OCP). These cards' connectivity provide the highest performing and most flexible interconnect solution for PCI Express Gen3 servers used in Enterprise Data Centers, High-Performance Computing, and Embedded environments

This chapter covers the following topics:

- Section 1.1, “Product Overview,” on page 10
- Section 1.2, “Features and Benefits,” on page 11
- Section 1.3, “Operating Systems/Distributions,” on page 12
- Section 1.4, “Connectivity,” on page 12

1.1 Product Overview

The following tables provide the ordering part number, port speed, number of ports, and PCI Express speed.

Table 4 - Single and Dual-port 10 Gigabit Ethernet Network Interface Cards

Ordering Part Number (OPN)	MCX341A-XCPN, MCX341A-XCQN MCX342A-XCPN, MCX342A-XCQN
Data Transmission Rate	10GigE
Number of ports	MCX341A-XCPN: single-port SFP+ MCX342A-XCPN: dual-port SFP+ MCX341A-XCQN: single-port SFP+ with IPMI and NC-SI support MCX342A-XCQN: dual-port SFP+ with IPMI and NC-SI support
PCI Express SERDES Speed	PCIe 3.0 x8 8GT/s
RoHS	R6
Adapter IC Part Number	MT27524A0-FCCR-BE

1.2 Features and Benefits

Table 5 - Features

PCI Express (PCIe)	Uses PCIe Gen 3.0 (1.1 and 2.0 compatible) through an x8 edge connector up to 8GT/s
10 Gigabit Ethernet	Mellanox cards comply with the following IEEE 802.3* standards: IEEE Std 802.3-2008 Ethernet IEEE Std 802.3ae 10 Gigabit Ethernet IEEE Std 802.3ba 40 Gigabit Ethernet IEEE Std 802.3ad Link Aggregation and Failover
Memory	PCI Express - stores and accesses Ethernet fabric connection information and packet data SPI - includes one 4MB SPI Flash device (W25Q32FVSSIG device by WIN-BOND-NUVOTON) EEPROM - accessible through the I ² C-compatible interface. The EEPROM capacity is 4KB.
RDMA over Converged Ethernet (RoCE)	Leveraging Data Center Bridging capabilities, RoCE provides efficient low latency RDMA services over Layer 2 Ethernet.
CPU offload	Adapter functionality enabling reduced CPU overhead allowing more available CPU
Sockets Acceleration	Applications utilizing TCP/UDP/IP transport can achieve industry leading throughput over 10GbE. The hardware-based stateless offload engines in ConnectX-3 Pro reduce the CPU overhead of IP packet transport. Sockets acceleration software further increases performance for latency sensitive applications.
Quality of Service (QoS)	Support for port-based Quality of Service enabling various application requirements for latency and SLA
Hardware-based I/O virtualization	ConnectX-3 Pro provides dedicated adapter resources and guaranteed isolation and protection for virtual machines within the server.
Virtualized Overlay Networks	ConnectX-3 Pro effectively addresses the increasing demand for an overlay network, enabling superior performance by introducing advanced NVGRE and VXLAN hardware offload engines that enable the traditional offloads to be performed on the encapsulated traffic. With ConnectX-3 Pro, data center operators can decouple the overlay network layer from the physical NIC performance, thus achieving native performance in the new network architecture.
SR-IOV	ConnectX-3 Pro SR-IOV technology provides dedicated adapter resources and guaranteed isolation and protection for virtual machines (VM) within the server. I/O virtualization with ConnectX-3 Pro gives data center managers better server utilization while reducing cost, power, and cable complexity.

1.3 Operating Systems/Distributions

- Novell SLES, Red Hat Enterprise Linux (RHEL), Fedora, CentOS and other Linux distributions.
- Microsoft Windows Server 2008/CCS 2003, HPC Server 2008
- OpenFabrics Enterprise Distribution (OFED)
- OpenFabrics Windows Distribution (WinOF)
- VMware ESX Server 3.5, vSphere 4.0/4.1

1.4 Connectivity

- Interoperable with 10GbE switches
- Passive copper cable with ESD protection
- Powered connectors for optical and active cable support
- QSFP to SFP+ connectivity through QSA module
- Passive copper cable with ESD protection

2 Interfaces

Each network interface card includes the following interfaces:

- “Ethernet Interface”
- “PCI Express Interface”
- “I²C-compatible Interface”
- “LED Interface”
- “Network Controller Sideband Interface (NC-SI)”

2.1 Ethernet Interface

The network ports of the ConnectX®-3 Pro network interface cards are compliant with the IEEE 802.3 Ethernet standards listed in Table 5, “Features,” on page 11.

2.2 PCI Express Interface

The ConnectX®-3 Pro network interface cards support PCI Express 3.0 (1.1 and 2.0 compatible) through an x8 edge connector. The device can be either a master initiating the PCI Express bus operations or a slave responding to PCI bus operations. The following lists the PCIe interface features:

- PCIe Base 3.0 compliant, 1.1 and 2.0 compatible
- 2.5, 5.0, or 8.0GT/s link rate x8
- Auto-negotiates to x8, x4, x2, or x1
- Support for MSI/MSI-X mechanisms

2.3 I²C-compatible Interface

A three hole footprint for I²C harness is provided as the I²C-compatible interface. See Figure 1.

Figure 1: I²C Harness

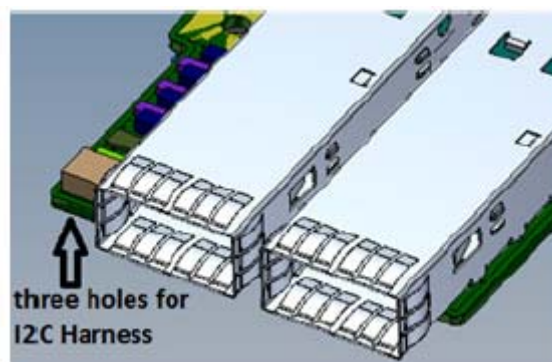

2.4 LED Interface

There are two I/O LEDs per port. For LED specifications please refer to [Section 7.4, “Adapter LED Operation,”](#) on page 43.

2.5 Network Controller Sideband Interface (NC-SI)

The adapter supports a slave Network Controller Sideband Interface (NC-SI) that can be connected to a BMC. The adapter's NC-SI implementation supports all mandatory NC-SI commands specified in the Network Controller Sideband Interface (NC-SI) Specification, Rev. 1.0.0a.

When the ConnectX-3 Pro network controller driver is running (on the main CPU) messages that target the adapter's NC-SI are forwarded by the adapter to the host memory, the adapter then fetches the message from the host memory and forwards it to the BMC over the NC-SI interface.

When the main CPU is powered-down or the adapter network controller is not running, messages that target the adapter's NC-SI are forwarded directly by the adapter to the BMC using the NC-SI interface without being copied to the host memory.

See [Appendix B.3, “NC-SI Interface Pinout,”](#) on page 49.

3 Hardware Installation

3.1 System Requirements

3.1.1 Hardware

This card requires a PCI Express connector as specified in the Open Compute Project Intel Motherboard spec v2.0.

3.1.2 Operating Systems/Distributions

Please refer to [Section 1.3, “Operating Systems/Distributions,”](#) on page 12.

3.1.3 Software Stacks

Mellanox OpenFabric software package - MLNX_EN for Linux, WinOF for Windows and ESX 5.1 for VMware. See [Chapter 4, “Driver Installation”](#).

3.2 Safety Precautions



The card is being installed in a system that operates with voltages that can be lethal. Before opening the case of the system, observe the following precautions to avoid injury and prevent damage to system components.

1. Remove any metallic objects from your hands and wrists.
2. Make sure to use only insulated tools.
3. Verify that the system is powered off and is unplugged.
4. It is strongly recommended to use an ESD strap or other antistatic devices.

3.3 Pre-installation Checklist

1. Verify that your system meets the hardware and software requirements stated above.
2. Shut down your system if active.
3. After shutting down the system, turn off power and unplug the cord.
4. Remove the card from its package. Please note that the card must be placed on an antistatic surface.
5. Check the card for visible signs of damage. Do not attempt to install the card if damaged.

3.4 Card Installation Instructions

Read all installation instructions before connecting the equipment to the power source.



This product is with no bracket which is usually a part of the connector cage protection. Please refrain from touching the cage directly during installation.

The cards require a PCI Express x4 or x8 Mezzanine connector. Please consult the host machine documentation for instructions on how to install a PCI Express Mezzanine connector.



If the card is installed in a PCI Mezzanine connector with less lanes than the card requires, then the Mezzanine card will not provide the optimum data transfer.

3.5 Cables and Modules

To obtain the list of supported cables for your NIC, go to www.mellanox.com => Products => Cables and Transceivers.

3.6 Identify the Card in Your System

3.6.1 On Windows

1. Open Device Manager on the server. Click start => Run, and then enter “devmgmt.msc”.
2. Expand System Devices and locate your Mellanox ConnectX-3 Pro network interface card.
3. Right click the mouse on your card's row and select properties to display the network interface card properties window.
4. Click the Details tab and select Device Instance Id (Windows 2003)
5. Hardware Ids (Windows 2008/R2) from the Properties pull-down menu.

Figure 2: PCI Device (Example)

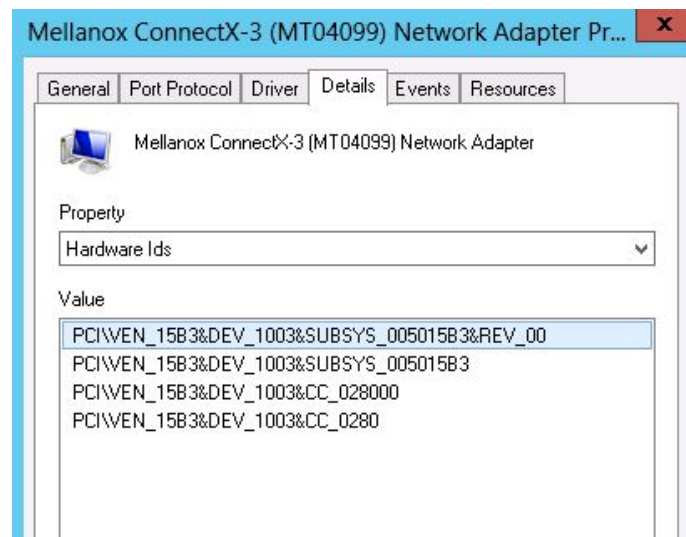

6. In the Value display box, check the fields VEN and DEV (fields are separated by '&'). In the display example above, notice the sub-string “PCI\VEN_15B3&DEV_1003”: VEN is equal to 0x15B3 – this is the Vendor ID of Mellanox Technologies; and DEV is equal to 1003 – this is a valid Mellanox Technologies PCI Device ID.



If the PCI device does not have a Mellanox adapter ID, return to Step 2 to check another device.



The list of Mellanox Technologies PCI Device IDs can be found in the PCI ID repository at <http://pci-ids.ucw.cz/read/PC/15b3>.

3.6.2 On Linux

Get the device location on the PCI bus by running `lspci` and locating lines with the string “Mellanox Technologies”:

```
> lspci |grep -i Mellanox  
27:00.0 Network controller: Mellanox Technologies MT27520 Family [ConnectX-3 Pro]
```

4 Driver Installation

4.1 Linux Driver

For Linux, download and install the latest MLNX_EN driver software package available via the Mellanox web site at: <http://www.mellanox.com> => Products => Software => Ethernet Drivers => ConnectX®-3 EN 10/40GigE Linux Driver => Download. Follow the installation instructions included in the download package (also available from the download page).

Note: The shown versions and/or parameter values in the example below may not reflect the latest or actual values for this product, and are included here for illustration purposes only.

4.1.1 Hardware and Software Requirements

Table 6 - Software and Hardware Requirements

Requirements	Description
Platforms	CPU architectures: <ul style="list-style-type: none"> • x86_64 • x86 • power-pc
Device ID	For the latest list of device IDs, please visit http://pci-ids.ucw.cz/read/PC/15b3 .
Operating System	Linux Operating Systems: <ul style="list-style-type: none"> • RedHat EL5.8 • RedHat EL5.9 • RedHat EL6.2 • RedHat EL6.3 • OEL6.2 + 2.6.32-279.19.1 • OEL6.3 + 2.6.32-279.19.1 • SLES11 SP1 • SLES11 SP2
Software Dependencies	To install the driver software, kernel sources must be installed on the machine. MLNX_EN driver cannot coexist with OFED software on the same machine. Hence when installing MLNX_EN all OFED packages should be removed (done by the mlnx_en install script)

4.1.2 Installing the Driver

Step 1. Download Driver Package

Please download the current driver package from <http://www.mellanox.com> => Products => Software => Ethernet Driver => Linux Driver => Download.

Step 2. Install Driver

Run the following commands to install the driver:

```
#> tar xzvf mlnx_en-1.5.10.tgz file
#> cd mlnx_en-1.5.10
#> ./install.sh
```

The package consists of several source RPMs. The install script rebuilds the source RPMs and then installs the created binary RPMs. The created kernel module binaries are placed under `/lib/modules/<kernel-ver>/updates/kernel/drivers/net/mlx4`. `mlnx_en` installer supports 2 modes of installation. The install scripts select the mode of driver installation depending on the running OS/kernel version.

1. Kernel Module Packaging (KMP) mode, where the source rpm is rebuilt for each installed flavor of the kernel. This mode is used for RedHat and SUSE distributions.
2. Non KMP installation mode, where the sources are rebuilt with the running kernel. This mode is used for vanilla kernels.

Note: If the Vanilla kernel is installed as rpm, please use the "`--disable-kmp`" flag when installing the driver.

The kernel module sources are placed under `/usr/src/mellanox-mlnx-en-1.5.10/`. Run the following commands to recompile the driver:

```
#> cd /usr/src/mellanox-mlnx-en-1.5.10/  
#> scripts/mlnx_en_patch.sh  
#> make  
#> make install
```

The uninstall and performance tuning scripts are installed.

Note: If the driver was installed without kmp support, the sources would be located under `/usr/src/mlnx_en-1.5.10/`

4.1.3 Loading the Driver

Step 1. Make sure no previous driver version is currently loaded

Run:

```
#> modprobe -r mlx4_en
```

Step 2. Load the new driver version

Run:

```
#> modprobe mlx4_en
```

The result is a new net-device appearing in `'ifconfig -a'` output.

4.1.4 Unloading the Driver

To unload the Ethernet driver run:

```
#> modprobe mlx4_en
```

4.1.5 Uninstalling the Driver

To uninstall the `mlnx_en` driver run:

```
#> /sbin/mlnx_en_uninstall.sh
```

4.2 Windows Driver

For Windows, download and install the latest Mellanox WinOF VPI for Windows software package available via the Mellanox web site at: <http://www.mellanox.com> => Products => Software => Ethernet Drivers => Windows SW/Driver => Download. Follow the installation instructions included in the download package (also available from the download page).

Note: The shown versions and/or parameter values in the example below may not reflect the latest or actual values for this product, and are included here for illustration purposes only.

4.2.1 Hardware and Software Requirements

Table 7 - Software and Hardware Requirements

Requirements	Description
Required Disk Space for Installation	100 MB
Operating Systems	Windows Server 2012 (64 bit only) Windows Server 2008 R2 (64 bit only)
Installer Privileges	The installation requires administrator privileges on the target machine.

4.2.2 Downloading MLNX_WinOF

Follow these steps to download the .exe according to your Operating System.

Step 1. Verify the machine architecture.

1. Open a CMD console (Click start-->Run and enter CMD).
2. Enter the following command:

```
> echo %PROCESSOR_ARCHITECTURE%
```

On an x64 (64-bit) machine, the output will be "AMD64".

Step 2. Go to the MLNX_WinOF for Windows Web page at <http://www.mellanox.com> => Products => Software => Ethernet Drivers => Windows SW/Drivers.

Step 3. Download the .exe image according to the architecture of your machine (see step Step 1.). The name of the .exe is in the following format MLNX_VPI_WinOF-<version>_All_<OS>_<arch>.exe.



Installing the incorrect .exe file is prohibited. If you do so, an error message will be displayed.

For example, if you try to install a 64-bit .exe on a 32-bit machine, the wizard will display the following (or a similar) error message:

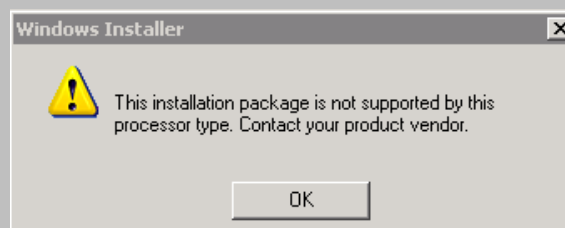

4.2.3 Extracting Files Without Running Installation

To extract the files without running installation, perform the following steps.

Step 1. Open a CMD console (Click Start-->Run and enter CMD).

Step 2. Enter the following command:

```
MLNX_VPI_WinOF-<version>_All_<OS>_<arch>.exe /a
```

Step 3. Click Next to create a server image.

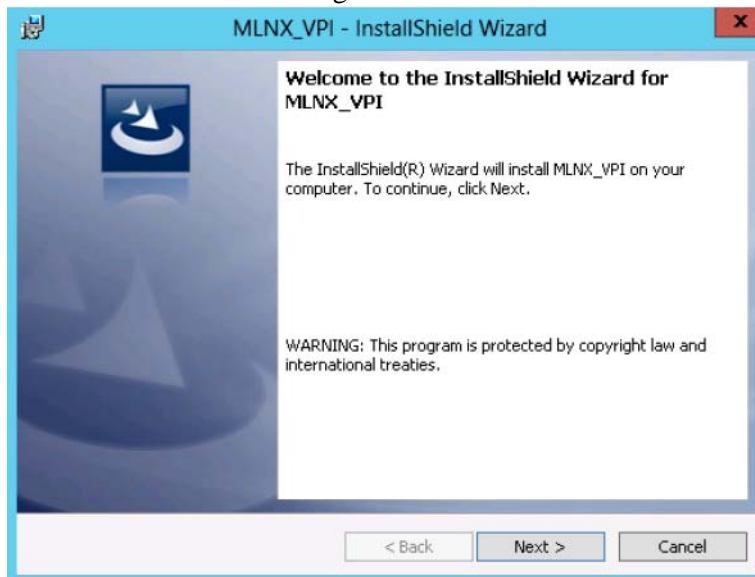

Step 4. Click Change and specify the location in which the files are extracted to.

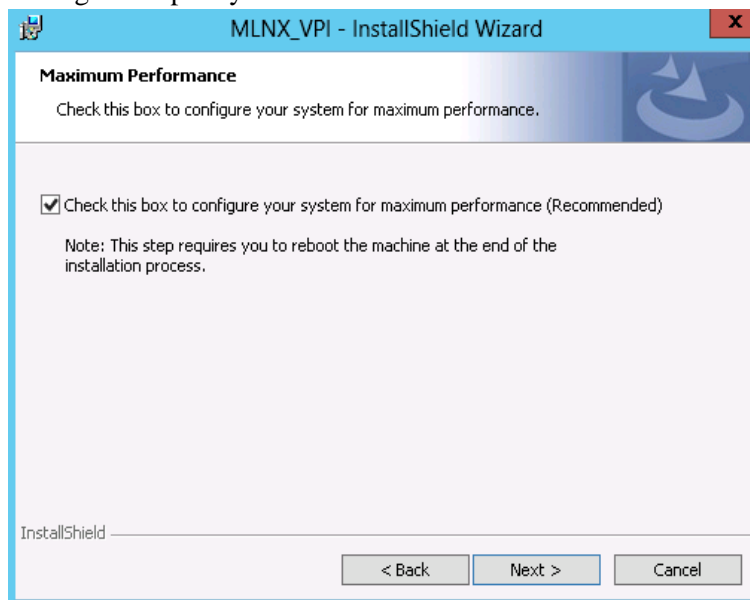

Step 5. Click Install to extract this folder, or click Change to install to a different folder.

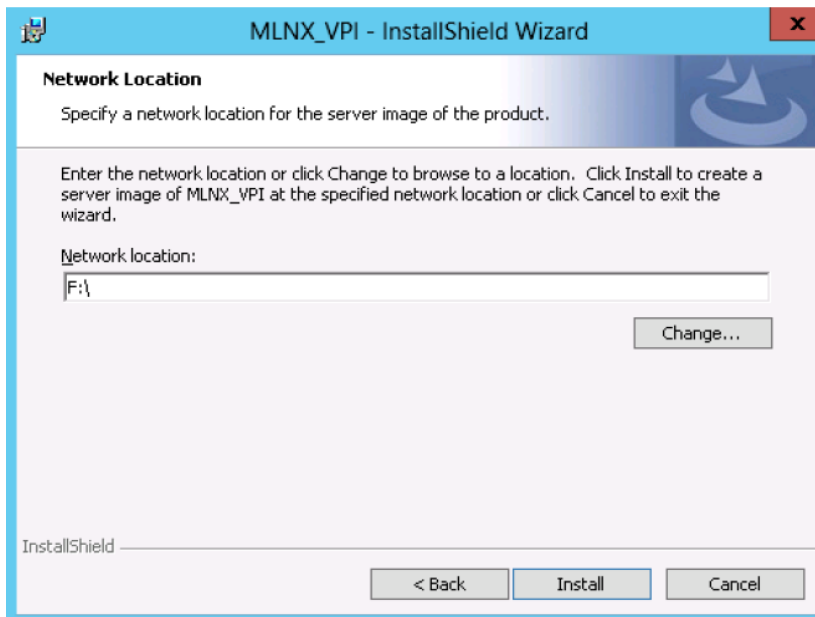

Step 6. To complete the extraction, click Finish.

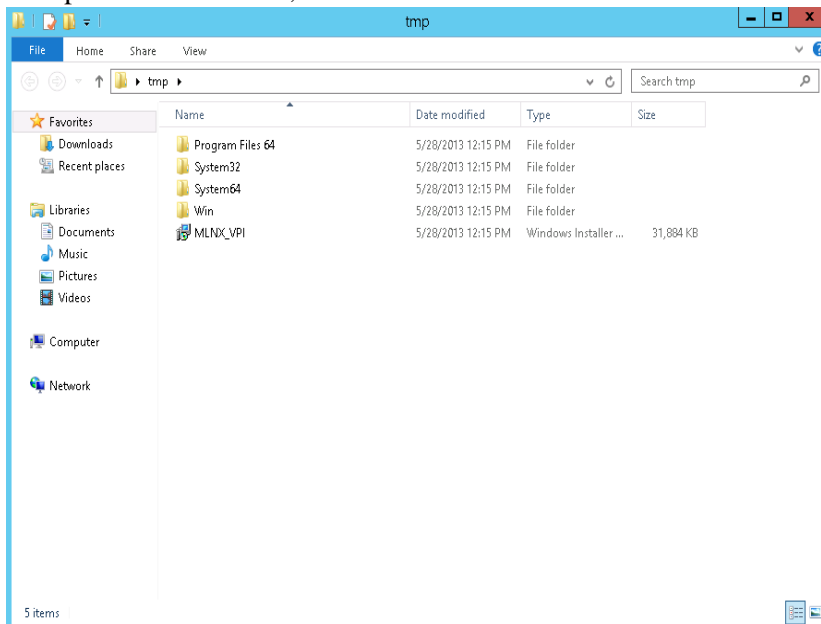

4.2.4 Installing MLNX_WinOF

This section provides instructions for two types of installation procedures:

- “Attended Installation”
An installation procedure that requires frequent user intervention.
- “Unattended Installation”

An automated installation procedure that requires no user intervention.



Both Attended and Unattended installations require administrator privileges.

4.2.4.1 Attended Installation

The following is an example of a MLNX_WinOF_win8 x64 installation session.

Step 1. Double click the .exe and follow the GUI instructions to install MLNX_WinOF.

To configure your setup to contain the logs option, please run the following command after opening a CMD console:

```
MLNX_VPI_WinOF-4_40_0_All_win8_x64.exe /v"/l*vx [LogFile] "
```

If you do not want to upgrade your firmware version, run the following command:

```
MLNX_VPI_WinOF-4_40_0_All_win8_x64.exe /v" MT_SKIPFWUPGRD=1 "
```

For further help, please run:

```
MLNX_VPI_WinOF-4_40_0_All_win8_x64.exe /v" /h "
```

Step 2. Click Next in the Welcome screen.

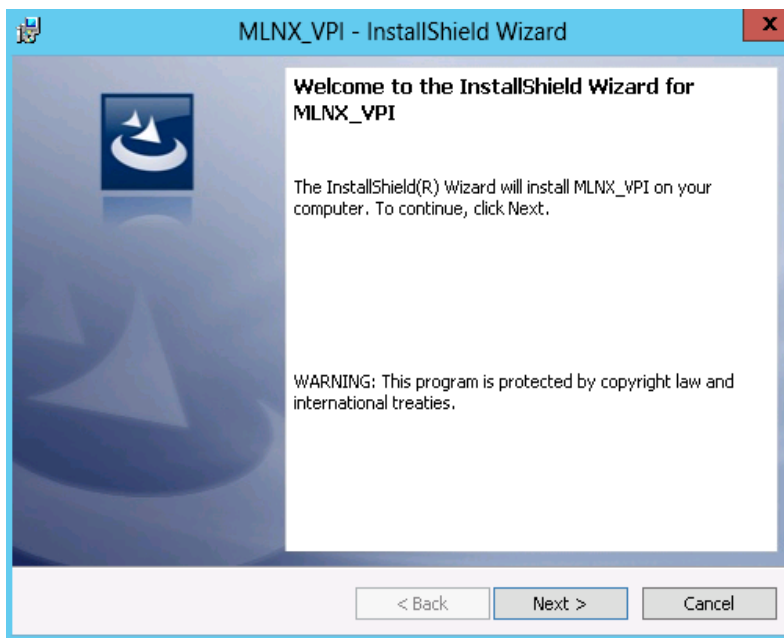

Step 3. Read then accept the license agreement and click Next.

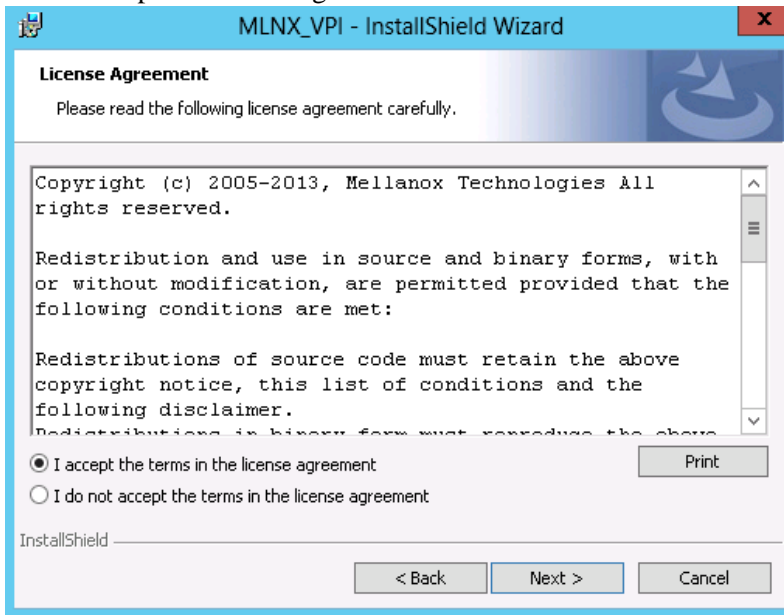

Step 4. Select the target folder for the installation.

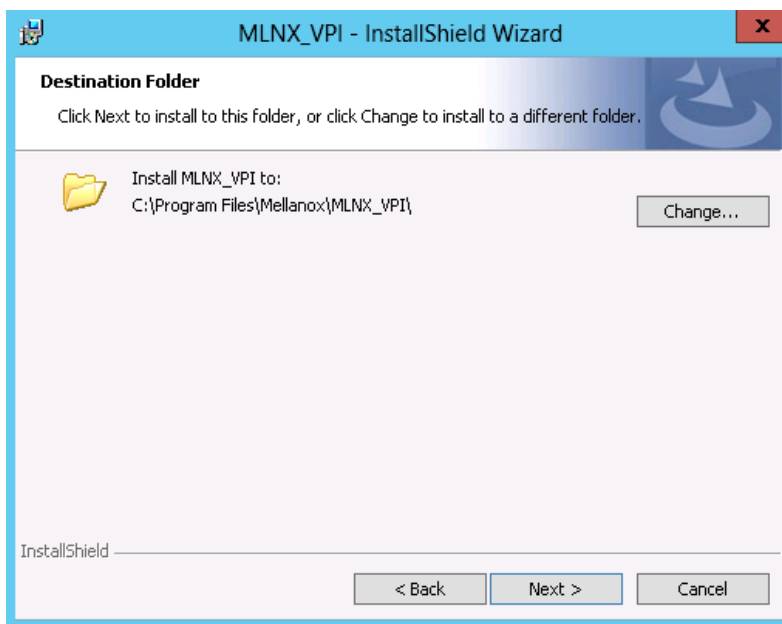

Step 5. The firmware upgrade screen will be displayed in the following cases:

- If the user has an OEM card, in this case the firmware will not be updated.

- If the user has a standard Mellanox card, and the firmware version is older than the one specified in WinOF Installation Guide 4.40, the firmware will be updated accordingly. However, if the user has both OEM card and Mellanox card, only Mellanox card will be updated.

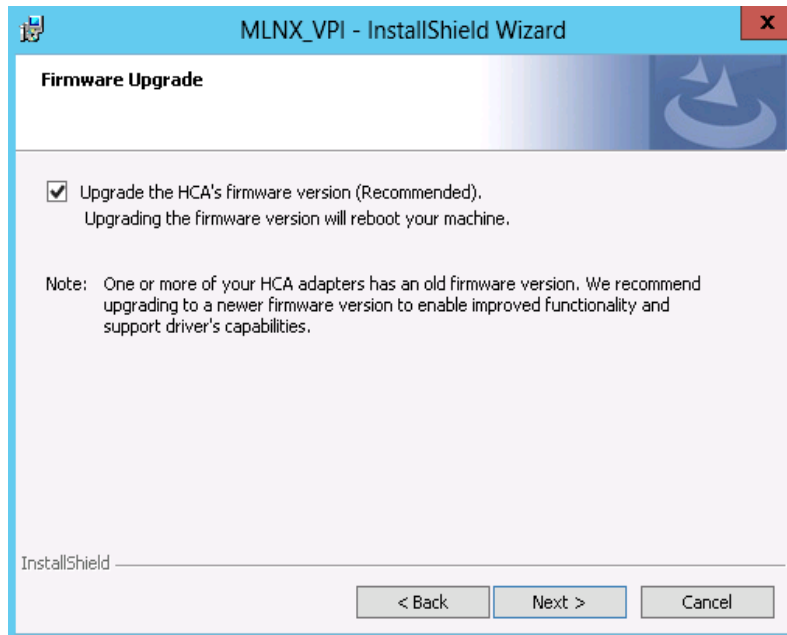

- Step 6.** Configure your system for maximum performance by checking the maximum performance box.

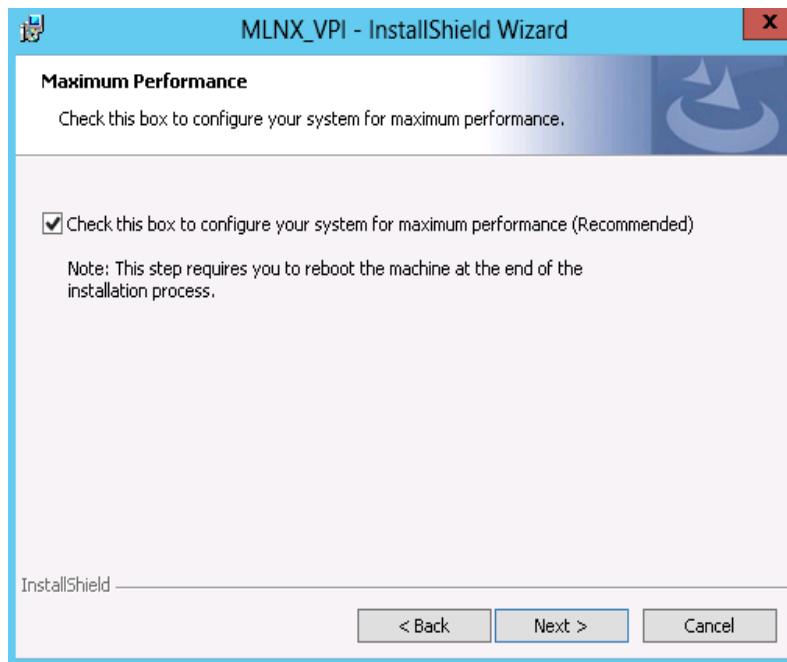



This step requires rebooting your machine at the end of the installation.

Step 7. Select a Complete or Custom installation, follow Step a and on, on page 26.

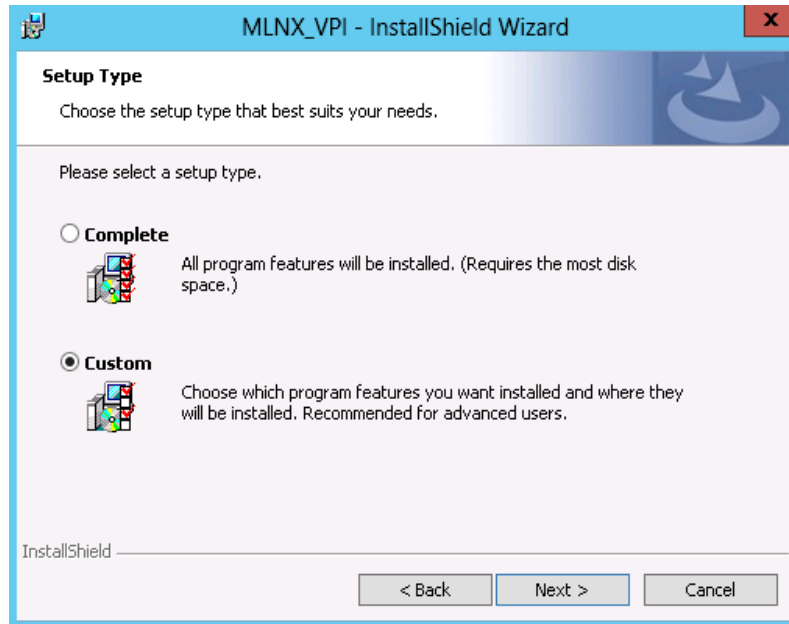

- a. Select the desired feature to install:
- OpenSM - installs Windows OpenSM that is required to manage the subnet from a host. OpenSM is part of the driver and installed automatically.
 - Performance tools - install the performance tools that are used to measure the InfiniBand performance in user environment.
 - Analyze tools - install the tools that can be used either to diagnose or analyze the InfiniBand environment.
 - SDK - contains the libraries and DLLs for developing InfiniBand application over IBAL.
 - Documentation: contains the User Manual and Installation Guide.
 - ND FLTR DLLs: contains the files for standalone installation of the mlx4nd provider.

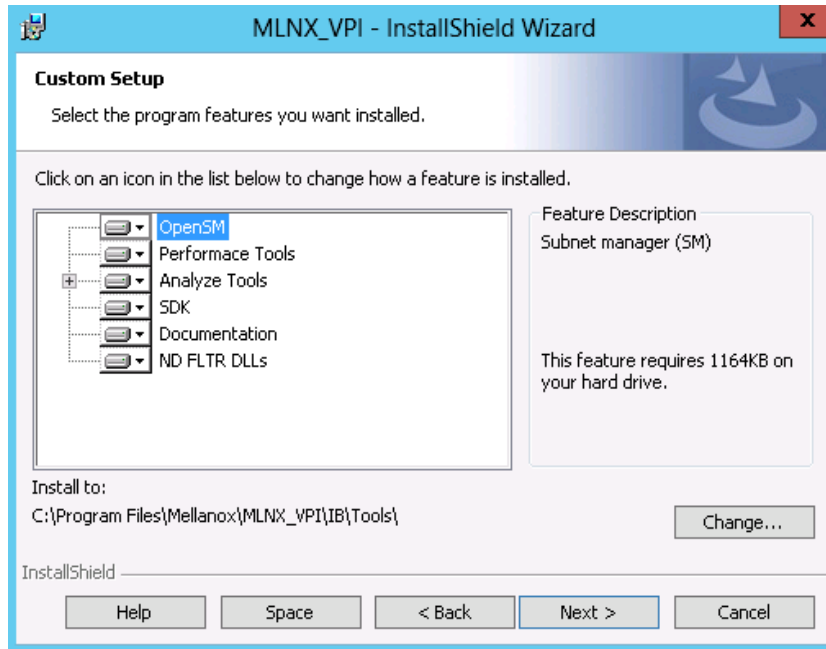

- b. Click Install to start the installation.

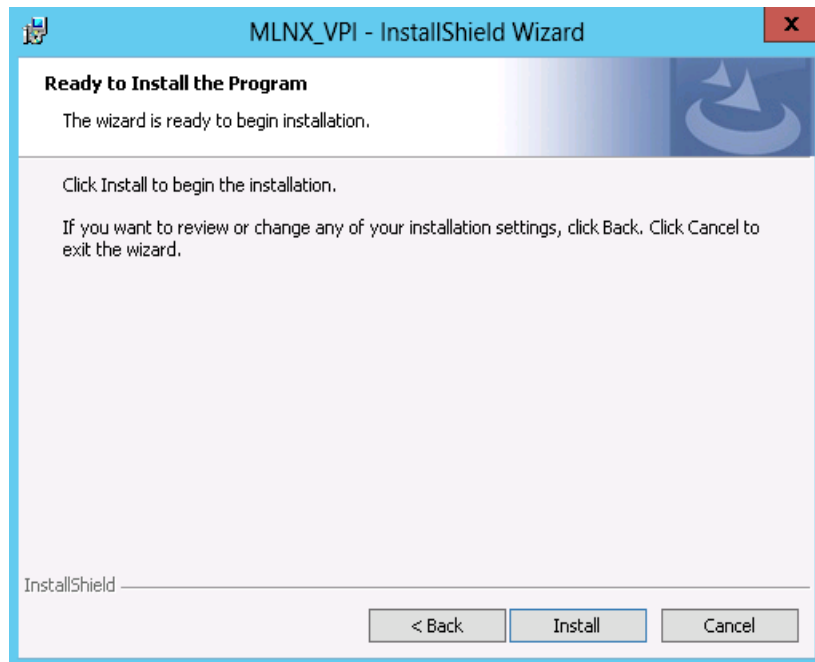

Step 8. Click Finish to complete the installation.

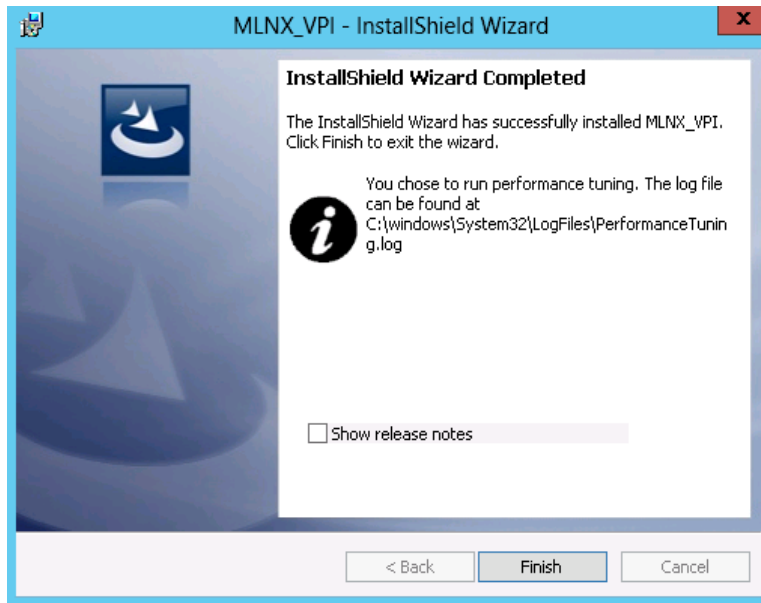

If the firmware upgrade fails, the following message will be displayed.

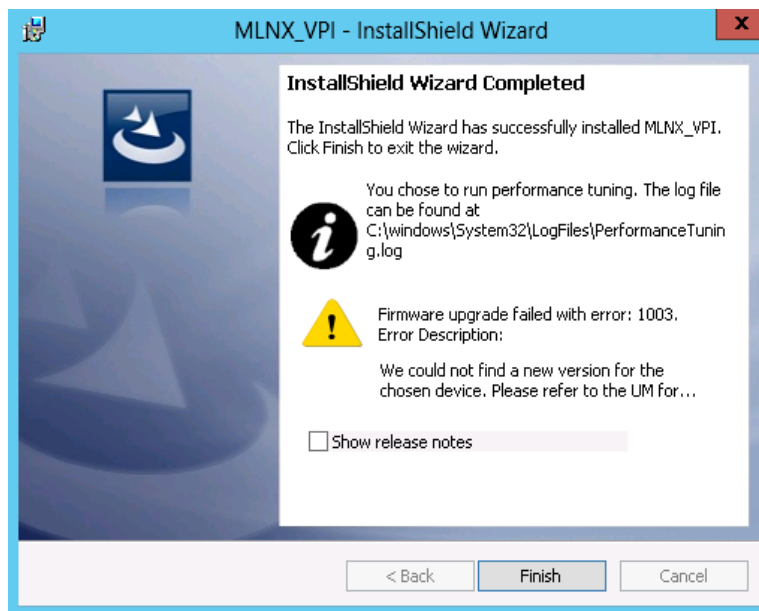

4.2.4.2 Unattended Installation

The following is an example of a MLNX_WinOF_win8 x64 unattended installation session.

Step 1. Open the CMD console (click Start > Run and enter 'cmd')

Step 2. Install the driver. Run:

```
> MLNX_VPI_WinOF-4_40_0_All_win8_x64.exe /S /v"/qn"
```

Step 3. [Optional] To configure your setup to contain the logs option, please run the following command:

```
> MLNX_VPI_WinOF-4_40_0_All_win8_x64.exe /S /v"/qn" /v"/l*vx [LogFile] "
```

Step 4. [Optional] If you do not want to upgrade your firmware version, run the following command:

```
> MLNX_VPI_WinOF-4_40_0_All_win8_x64.exe /S /v"/qn" /v" MT_SKIPFWUPGRD=1 "
```

For further help, please run:

```
> MLNX_VPI_WinOF-4_40_0_All_win8_x64.exe /v" /h"
```

4.2.5 Upgrading MLNX_WinOF

The MLNX_WinOF driver upgrades automatically MLNX_WinOF Windows 2008R2 driver by uninstalling the previous version and installs the new driver. However, MLNX_WinOF driver upgrade in Windows 2012 driver do not completely uninstall the previous version.

- In Windows 2012 (MLNX_WinOF Rev. 4.2 and above), the network configuration is saved upon driver upgrade.
- In Windows 2008 R2 the existing configuration files are not saved upon driver upgrade.

4.2.6 Installation Results

Upon installation completion, you can verify the successful addition of the network card(s) through the Device Manager. To see the Mellanox network adapter device, and the Ethernet or IPoIB network device (depending on the used card) for each port, display the Device Manager and expand “System devices” or “Network adapters”.

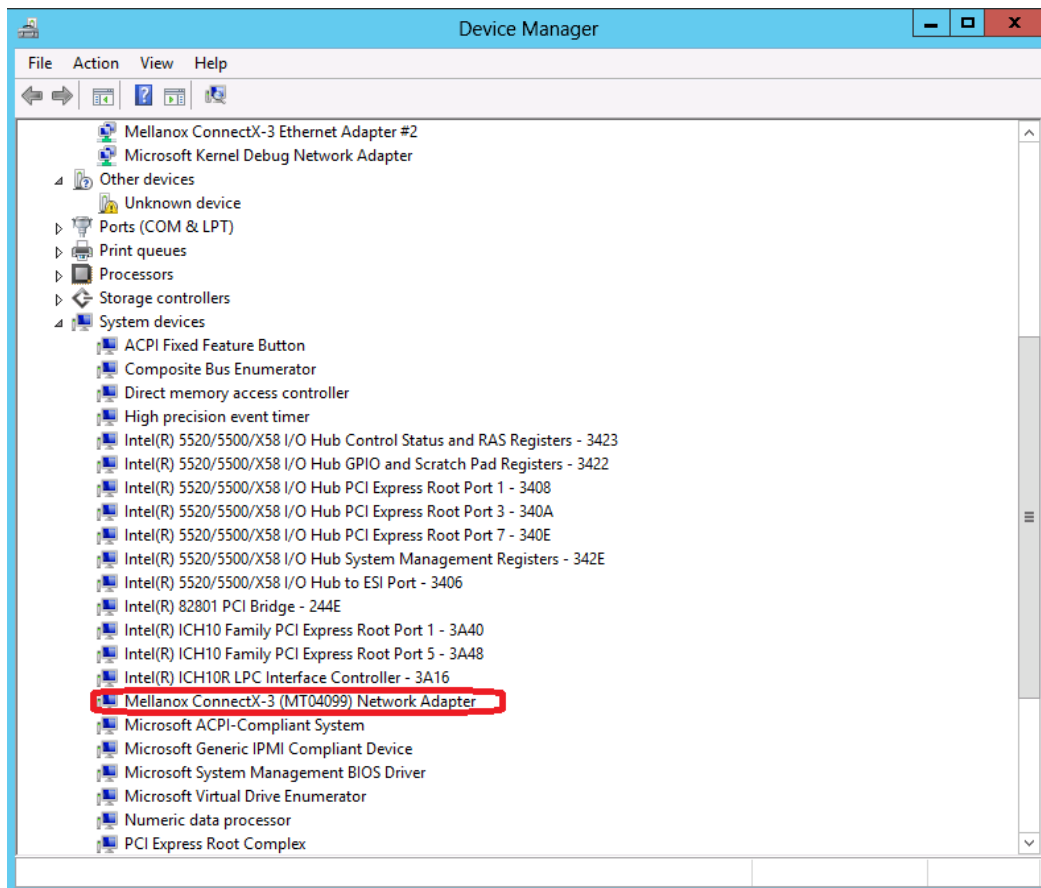

4.2.7 OpenSM Activation

OpenSM is a service required by managed networks in InfiniBand environments, and must be activated in one of the machines running on the subnet, otherwise the interface link will not come up. If the cards are connected to a managed network, there is no need to run OpenSM. Only one OpenSM should run per subnet.

In Ethernet interfaces, running OpenSM is not required.

OpenSM does not run as a service during installation as it requires the GUID parameter to decide on which port to work. Setting OpenSM upon setup results in it working only for the first port and not for the others.

➤ **To run OpenSM as a service, assuming the package was installed in the default path, use:**

```
sc create OpenSM1 binPath= "c:\Program Files\Mellanox\MLNX_VPI\IB\Tools\
opnsm.exe --service" start=auto"
```

➤ **To start the service, run:**

```
sc start opnsm
```

For further information, please refer to the “OpenSM - Subnet Manager” chapter in the User Manual.

4.2.8 Uninstalling MLNX_WinOF

4.2.8.1 Attended Uninstall

➤ *To uninstall MLNX_WinOF on a single node, perform one of the following options:*

1. Click Start-> Control Panel-> Programs and Features-> MLNX_VPI-> Uninstall.
(NOTE: This requires elevated administrator privileges.)
2. Double click the .exe and follow the instructions of the install wizard.
3. Click Start-> All Programs-> Mellanox Technologies-> MLNX_WinOF-> Uninstall MLNX-
_WinOF.

4.2.8.2 Unattended Uninstall

➤ *To uninstall MLNX_WinOF in unattended mode, perform the following:*

Step 1. Open a CMD console.

Step 2. Uninstall the driver. Run:

```
MLNX_VPI_WinOF-4_40_0_All_win8_x64.exe /S /x /v"/qn"
```

4.2.9 Assigning Port IP After Installation

By default, your machine is configured to obtain an automatic IP address via a DHCP server. In some cases, the DHCP server may require the MAC address of the network adapter installed in your machine.

➤ *To obtain the MAC address:*

Step 1. Open a CMD console

Step 2. Display the MAC address as “Physical Address”

```
ipconfig /all
```

Configuring a static IP is the same for both IPoIB and Ethernet adapters.

➤ *To assign a static IP address to a network port after installation:*

Step 1. Open the Network Connections window. Locate Local Area Connections with Mellanox devices.

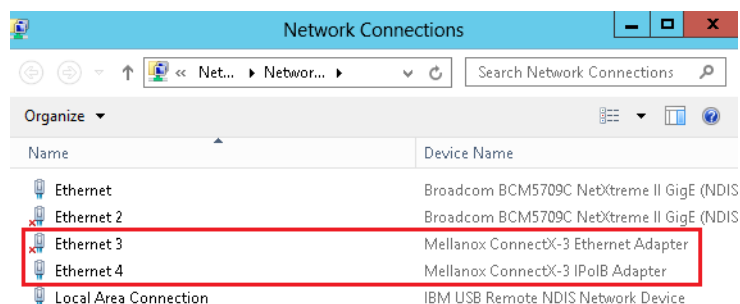

Step 2. Right-click a Mellanox Local Area Connection and left-click Properties.

Step 3. Select Internet Protocol Version 4 (TCP/IPv4) from the scroll list and click Properties.

Step 4. Select the “Use the following IP address:” radio button and enter the desired IP information.

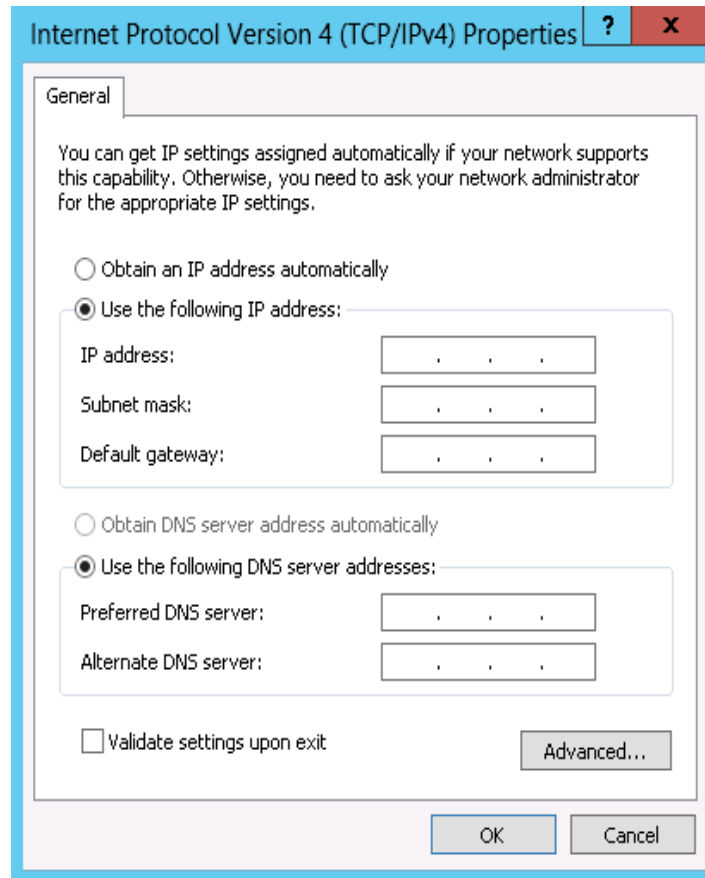

Step 5. Click OK.

Step 6. Close the Local Area Connection dialog.

Step 7. Verify the IP configuration by running ‘ipconfig’ from a CMD console.

```
> ipconfig
...
Ethernet adapter Local Area Connection 4:

    Connection-specific DNS Suffix  . :
    IP Address . . . . . : 11.4.12.63
    Subnet Mask . . . . . : 255.255.0.0
    Default Gateway . . . . . :
    ...
```

4.3 VMware Driver

For VMware download and install the latest Mellanox OFED Driver for VMware® ESXi Server-software package available via the Mellanox web site at: <http://www.mellanox.com> => Products => Software => Ethernet Drivers => VMware Drivers => Download. Follow the installation instructions included in the download package (also available from the download page).

4.3.1 Installing and Running the VBI Driver on ESXi-5.x

4. Log into the VMware ESXi server machine as root.

5. You can either:

- a. Remove any earlier version of the driver from your VMware ESXi server machine prior to installing the new version. Run:

```
#> esxcli software vib list
#> esxcli software vib remove -n net-mlx4-en
```

- b. Install the mlx4_en driver VIB package. Run:

```
#> esxcli software vib install -v <vib_url>
```

- c. Reboot ESXi server (The driver will be loaded automatically).

OR

- a. Update the driver. Run:

```
#> esxcli software vib update -v <vib_url>
```

- b. Reboot ESXi server (The driver will be loaded automatically).

» **To verify that the driver is loaded, run:**

```
#> vmkload_mod -l | grep mlx4_en
```

» **To query network uplinks installed on your machine, run:**

```
#> esxcli network nic list
```

The number of uplinks claimed by MLX4_EN driver should be displayed.



In Non Multifunction Mode, port 2 is identified as a pseudo device. Therefore devices are not seen by vSphere when added as uplink.

For further information on how to manipulate the uplink, please refer to [Section 5.3, “Adding the Device as an uplink to an Existing Vswitch using the CLI,”](#) on page 10 of the VMware User Manual. See [Table 2, “Documents List,”](#) on page 8.

4.3.2 Installing and Running the offline_bundle Driver on ESXi-5.x

1. Copy the offline_bundle zip file to ESXi 5.0 machine and extract its contents.

2. You can install the driver in one of the following ways:

- a. Remove any earlier version of the driver from your VMware ESXi server machine prior to installing the new version. Run:

```
#> esxcli software vib list
#> esxcli software vib remove -n net-mlx4-en
```

- b. Install the mlx4_en driver offline_bundle package. Run:

```
#> esxcli software vib install -d
<path>/mlx4_en-mlnx-1.6.1.2-offline_bundle-471530.zip
```

- c. Reboot ESXi server. (The driver will be loaded automatically).

OR

- a. Update the driver. Run:

```
#> esxcli software vib update -n net-mlx4-en -d  
<path>/mlx4_en-mlnx-1.6.1.2-offline_bundle-471530.zip
```

- b. Reboot ESXi server. (The driver will be loaded automatically).

- » **To verify that the driver is loaded, run:**

```
#> vmkload_mod -l | grep mlx4_en
```

- » **To query network uplinks installed on your machine, run:**

```
#> esxcli network nic list
```

The number of uplinks claimed by MLX4_EN driver should be displayed.



In Non Multifunction Mode, port 2 is identified as a pseudo device. Therefore devices are not seen by vSphere when added as uplink.

For further information on how to manipulate the uplink, please refer to [Section 5.3](#), “Adding the Device as an uplink to an Existing Vswitch using the CLI,” on page 10 of the VMware User Manual. See [Table 2](#), “Documents List,” on page 8.

4.3.3 Removing the VIB/offline_bundle Driver

- » **To remove the VIB/offline_bundle driver package from the ESXi server machine, run:**

```
#> esxcli software vib remove -n net-mlx4-en
```

4.4 FlexBoot

FlexBoot supports remote Boot over Ethernet. This technology is based on the Preboot Execution Environment (PXE) standard specification, and FlexBoot software is based on the open source iPXE project (see www.ipxe.org). For more information go to <http://www.mellanox.com> => Products => Software => Ethernet Drivers => Download.

5 Updating Card Firmware

Each card is shipped with the latest version of qualified firmware at the time of manufacturing. However, Mellanox issues firmware updates occasionally and the most recent firmware can be obtained from: <http://www.mellanox.com> => Support. Check that the firmware on your card is the latest found on the Mellanox site, if not update to the latest version found on the Mellanox web site.

Firmware can be updated on the stand-alone single card using the **flint** tool of the *Mellanox Firmware Tools (MFT)* package. This package is available for download, along with its user manual, from the Mellanox Firmware Tools page. See <http://www.mellanox.com> => Software => Firmware Tools.

The following steps describe how to retrieve the PSID (firmware identification) and programmed firmware version of your network interface card. They also describe how to update the card with the latest firmware version available.

1. Retrieve the PSID and firmware version:
 - a. Install the MFT package. The package is available at <http://www.mellanox.com> => Products => Software => Firmware Tools. Make sure to download the package corresponding to your computer's operating system.
 - b. Enter: `mst start`.
 - c. Get the Mellanox *mst device name* using the command "`mst status`". The *mst device name* will be of the form: `/dev/mst/mt4099_pci_cr0`.
 - d. Get the PSID (firmware identification) and programmed firmware version using the command.

Note: The shown versions and/or parameter values in the example below may not reflect the latest or actual values for this product, and are included here for illustration purposes only.

```
flint -d /dev/mst/mt4099_pci_cr0 q
Image type:      ConnectX
FW Version:      2.30.4260
Device ID:       4099
Description:     Node          Port1          Port2
Sys image
GUIDs:           ffffffff ffffffff
ffffffffff ffffffff
MACs:            0002c9305350
0002c9305351
VSD:
PSID:            MT_1080120023
```

1. Compare the programmed firmware version with the latest available.
 - a. Go to Mellanox's web site: <http://www.mellanox.com/supportdownloader>. See [Figure 3](#).
 - b. Enter your card PSID to display the latest firmware file. The file name of the binary is composed by combining the firmware name, the firmware release version, and the card part number.

Note: Please contact Mellanox System Support if you cannot find the firmware binary for your card.

Figure 3: Support Download Assistant

Mellanox TECHNOLOGIES

Mellanox - Support Download Assistant

Support Index | Documentation Login | Customer Support | Returns | Home

CLEAR PSID or OPN

Browse for Product Support

Select a Family	Select a Line	Select an OPN	Select a PSID (Rev)	Product Support Information
Adapter Cards Switches Gateways	Select an item from previous column			

1. If a newer firmware version exists for your network interface card on the Web, update the firmware as follows:
 - a. Download the firmware (image) zip file from the Support Downloader (see Step 2a above).
 - b. Unzip the firmware image.
 - c. Burn the firmware image. Enter:

```
> flint -d /dev/mst/mt4099_pci_cr0 -i <binary image> burn
```

- a. Reboot the computer.
- b. Enter: mst start.
- c. Verify that the card firmware was updated successfully.

```
> flint -d /dev/mst/mt4099_pci_cr0 q
Image type:      ConnectX
FW Version:      2.9.4100
Device ID:       4099
...
```

6 Troubleshooting

6.1 General

GUID of ConnectX-3 Pro Ethernet adapter cards	<ul style="list-style-type: none"> • Please use the GUID value returned by the fabric/driver utilities (not 0xfffff). See Appendix A.1, “Retrieving Card GUID,” on page 46.
Server unable to find the adapter	<ul style="list-style-type: none"> • Ensure that the adapter is placed correctly • Make sure the adapter slot and the adapter are compatible • Install the adapter in a different PCI Express slot • Use the drivers that came with the adapter or download the latest • Make sure your motherboard has the latest BIOS • Try to reboot the server
The adapter no longer works	<ul style="list-style-type: none"> • Reseat the adapter in its slot or a different slot, if necessary • Try using another cable • Reinstall the drivers for the network driver files may be damaged or deleted • Reboot the server
Adapters stopped working after installing another adapter	<ul style="list-style-type: none"> • Try removing and re-installing all adapters • Check that cables are connected properly • Make sure your motherboard has the latest BIOS
Link indicator light is off	<ul style="list-style-type: none"> • Ensure that adapter driver/s is loaded • Try another port on the switch • Make sure the cable is securely attached • Check your are using the proper cables that do not exceed the recommended lengths • Verify that your switch and adapter port are compatible
Link light is on, but with no communication established	<ul style="list-style-type: none"> • Check that the latest driver is loaded • Check that both the adapter and its link are set to the same speed and duplex settings

6.2 Linux

Environment Information	<pre>cat/etc/issue uname -a cat/proc/cupinfo grep 'model name' uniq ofed_info head -1 ifconfig -a ethtool <interface> ethtool -i <interface_of_Mellanox_port_num> ibdev2netdev</pre>
Card Detection	<pre>lspci grep -i Mellanox</pre>
Mellanox Firmware Tool (MFT)	<p>Download and install MFT: http://www.mellanox.com/content/pages.php?pg=management_tools&menu_section=34 Refer to the User Manual for installation instructions.</p> <p>Once installed, run:</p> <pre>mst start mst status flint -d <mst_device> q</pre>
Ports Information	<pre>ibstat lsv_devinfo</pre>
Firmware Version Upgrade	<p>To download the latest firmware version refer to http://www.mellanox.com/supportdownloader</p>
Collect Log File	<pre>/var/log/messages dmesg > system.logF</pre>

6.3 Windows

Environment Information	<p>From the Windows desktop choose the Start menu and run: msinfo32</p> <p>To export system information to a text file, choose the Export option from the File menu.</p> <p>Assign a file name and save.</p>
Mellanox Firmware Tool (MFT)	<p>Download and install MFT: http://www.mellanox.com/content/pages.php?pg=management_tools&menu_section=34</p> <p>Refer to the User Manual for installation instructions.</p> <p>Once installed, open a CMD window and run:</p> <pre>cd C:\Program Files\Mellanox\WinMFT mst start mst status flint -d <mst_device> q</pre>
Ports Information	vstat
Firmware Version Upgrade	<p>Download the latest firmware version using the PSID/board ID: http://www.mellanox.com/supportdownloader/</p> <pre>flint -d <mst_device> -i <firmware_bin_file> b</pre>
Collect log file	<ul style="list-style-type: none"> • Event log viewer • MST device logs: <ul style="list-style-type: none"> • mst start • mst status • C:\Users\Administrator> flint -d <mst_device> dc > dump_configuration.log • C:\Users\Administrator> mstdump <mst_device> dc > mstdump.log

7 Specifications

7.1 MCX341A-XC[P/Q]N Specifications

Table 8 - MCX341A-XC[P/Q]N Specifications Table

Physical	Size: 2.68in. x 4.3 in. (68mm x 110mm)
	Connector: SFP+ 10Gb/s
Protocol Support	Ethernet: 10GBASE-SR, 10GBASE-LR, and 10GBASE-CX
	Data Rate: 1/10Gb/s – Ethernet
	PCI Express Gen3: SERDES @ 8.0GT/s, 8 lanes (2.0 and 1.1 compatible)
Power and Environmental	Voltage: 5V, 3.3V
	Typ Power: Passive Cables 3.72W
	Max Power: Passive Cables 5.10W
	Max power available through SFP+ port: 1W
	Temperature: Operational: 0°C to 45°C Non-operational: 0°C to 70°C
	Humidity: 90% relative humidity ^a
	Air Flow: 300LFM ^b
Regulatory	EMC: Refer to the following link: www.mellanox.com/related-docs/user_manuals/Regulatory_and_Compliance_Guide.pdf
	Safety: IEC/EN 60950-1:2006 ETSI EN 300 019-2-2 IEC 60068-2- 64, 29, 32
	RoHS: RoHS-R6
Cable Support	Please refer to www.mellanox.com => Products => Cables and Transceivers

a. For both operational and non-operational states

b. Air flow is measured ~1” from the Mezz from the cooling air inlet side.

7.2 MCX342A-XC[P/Q]N Specifications

Table 9 - MCX342A-XC[P/Q]N Specifications Table

Physical	Size: 2.68in. x 4.3 in. (68mm x 110mm)
	Connector: SFP+ 10Gb/s
Protocol Support	Ethernet: 10GBASE-SR, 10GBASE-LR, and 10GBASE-CX
	Data Rate: 1/10Gb/s – Ethernet
	PCI Express Gen3: SERDES @ 8.0GT/s, 8 lanes (2.0 and 1.1 compatible)
Power and Environmental	Voltage: 5V, 3.3V
	Typ Power: Passive Cables 5.09W
	Max Power: Passive Cables 6.38W
	Max power available through SFP+ port: 1W
	Temperature: Operational: 0°C to 45°C Non-operational: 0°C to 70°C
	Humidity: 90% relative humidity ^a
	Air Flow: 300LFM ^b
Regulatory	EMC: Refer to the following link: www.mellanox.com/related-docs/user_manuals/Regulatory_and_Compliance_Guide.pdf
	Safety: IEC/EN 60950-1:2006 ETSI EN 300 019-2-2 IEC 60068-2- 64, 29, 32
	RoHS: RoHS-R6
Cable Support	Please refer to www.mellanox.com => Products => Cables and Transceivers

a. For both operational and non-operational states

b. Air flow is measured ~1” from the Mezz from the cooling air inlet side.

7.3 Board Mechanical Drawing and Dimensions



All dimensions are in millimeters.
All the mechanical tolerances are +/- 0.1mm

Figure 4: Mechanical Drawing of the Single-port MCX341A Mezzanine Card

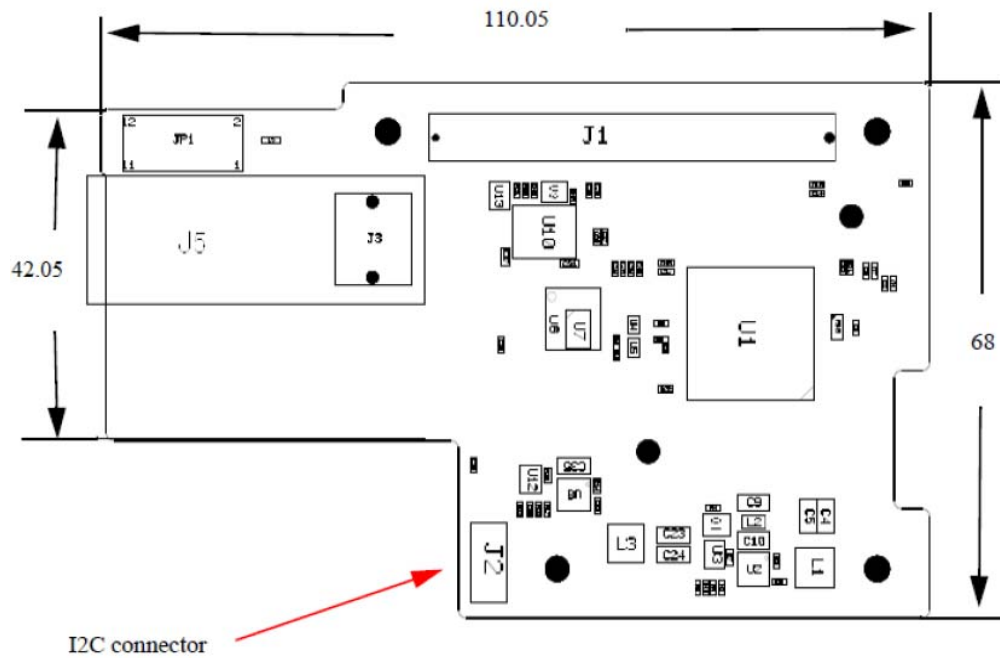
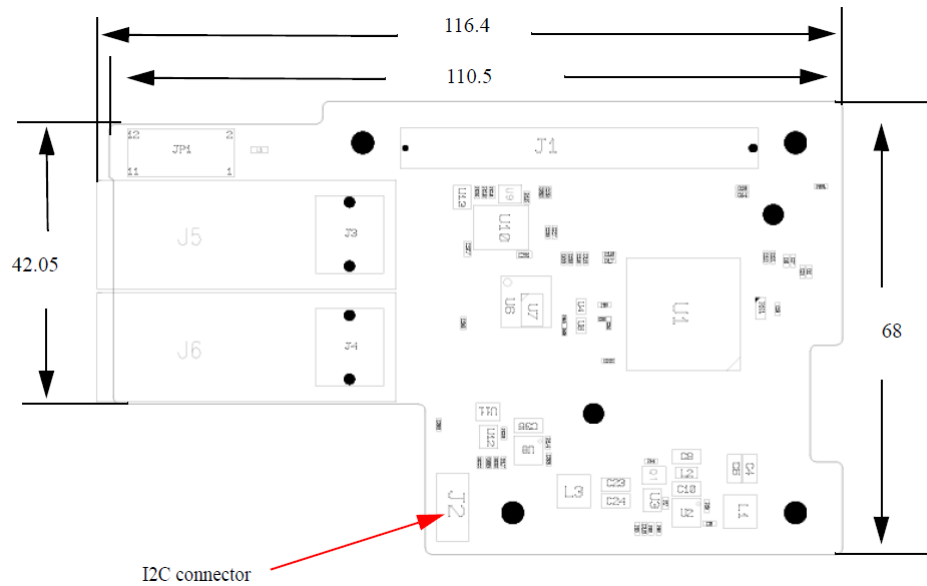

Figure 5: Mechanical Drawing of the Dual-port MCX342A Mezzanine Card

7.4 Adapter LED Operation

There are two I/O LEDs per port. See [Table 10](#) for different LED functions.

Table 10 - Physical and Logical Link Indication

Port and LED	Link LED	Function
P0-LED0	Physical link - Green	10G link is present
	Physical link - Yellow	Other link status is present
P0-LED1	Logical Link/ Activity - Green	
P1-LED0	Physical link - Green	10G link is present
	Physical link - Yellow	Other link status is present
P1-LED1	Logical Link/ Activity - Green	

Appendix A: Finding the MAC and Serial Number on the Card

Each Mellanox card has a label on the print side that shows the card serial number and the card MAC for Ethernet protocol.

Note: The revision indicated on the labels in the following figures do not necessarily represent the latest revision of the card. Card revision changes are communicated via Product Change Notification (PCN) documents that are available via card suppliers.

Figure 6: MCX341A-XCPN Board Label (Example only - see Note)



Figure 7: MCX341A-XCQN Board Label (Example only - see Note)**Figure 8: MCX342A-XCPN Board Label (Example only - see Note)**

Figure 9: MCX342A-XCQN Board Label (Example only - see Note)



A.1 Retrieving Card GUID

On ConnectX-3 Pro Ethernet NICs, there is a mismatch between the GUID value returned by firmware management tools and that returned by fabric/driver utilities that read the GUID via device firmware (e.g., using `ibstat`). `Mlxburn/flint` returns `0xffff` as GUID while the utilities return a value derived from the MAC address. For all driver/firmware/software purposes, the latter value should be used. Please see the below example.

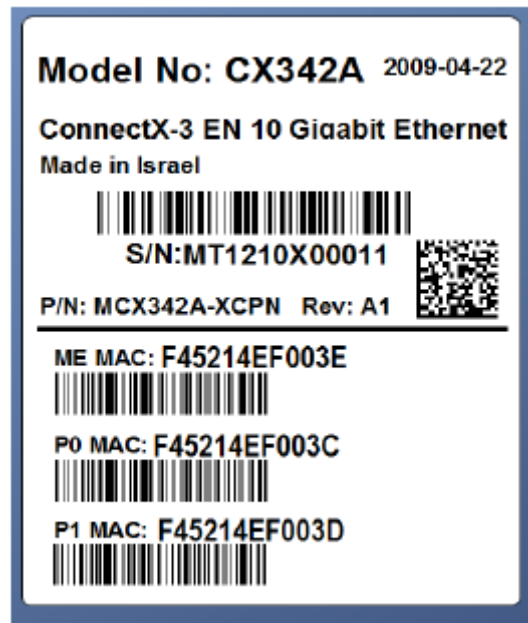
```

ibstat
CA 'mlx4_0'
  CA type: MT4103
  Number of ports: 2
  Firmware version: 2.30.5000
  Hardware version: 0
  Node GUID: 0x0002c90300e8eef0
  System image GUID: 0x0002c90300e8eef0
  Port 1:
    State: Down
    Physical state: Disabled
    Rate: 10
    Base lid: 0
    LMC: 0
    SM lid: 0
    Capability mask: 0x00010000
    Port GUID: 0x0000000000000000
    Link layer: Ethernet
  Port 2:
    State: Down
    Physical state: Disabled
    Rate: 10
    Base lid: 0
    LMC: 0
    SM lid: 0
    Capability mask: 0x00010000
    Port GUID: 0x0000000000000000
    Link layer: Ethernet

```

```

flint -d /dev/mst/mt4103_pci_cr0 -qq q

-W- Running quick query - Skipping full image integrity checks.

Image type:      ConnectX
FW Version:      2.30.5000
Device ID:       4103
Description:     Node          Port1          Port2          Sys image
GUIDs:          0002c90300e8eef0 0002c90300e8eef1 0002c90300e8eef2
0002c90300e8eef3
MACs:           0002c9e8eef0      0002c9e8eef1
VSD:            n/a
PSID:           MT_1200111023

```

Appendix B: Interface Connectors Pinout

B.1 PCI Express x8 Connector Pinout

The cards use a standard PCI Express x8 connector and the PCI Express x8 standard pinout according to the PCI Express 3.0 specification.

Figure 10: PCIe Connector Pinout

61				1
62	P12V-1	RSVD/MEZZ_PRSENT1_N		2
63	P12V-2	PSV_AUX-1		3
64	P12V-3	PSV_AUX-2		4
65	GND-26	PSV_AUX-3		5
66	GND-27	GND-1		6
67	P3V3_AUX-2	GND-2		7
68	GND-28	P3V3_AUX-1		8
69	GND-29	GND-3		9
70	P3V3-5	GND-4		10
71	P3V3-6	P3V3-1		11
72	P3V3-7	P3V3-2		12
73	P3V3-8	P3V3-3		13
74	GND-30	P3V3-4		14
75	LAN_3V3STB_ALERT_N	RSVD/MEZZ_CPRSENT1_N		15
76	SMB_LAN_3V3STB_CLK	RSVD/MEZZ_CPRSENT2_N		16
77	SMB_LAN_3V3STB_DAT	RSVD/SSD_PRSENT_N		17
78	PCIE_WAKE_N	RST_PLT_MEZZ_N		18
79	RSVD/DA_DSS	RSVD/MEZZ_SMCLK		19
80	GND-31	RSVD/MEZZ_SMDATA		20
81	RSVD/SATA_TX+	GND-5		21
82	RSVD/SATA_TX-	GND-6		22
83	GND-32	RSVD/SATA_RX+		23
84	GND-33	RSVD/SATA_RX-		24
85	CLK_100M_MEZZ2_DP	GND-7		25
86	CLK_100M_MEZZ2_DN	GND-8		26
87	GND-34	RSVD/CLK_100M_MEZZ1_DP		27
88	GND-35	RSVD/CLK_100M_MEZZ1_DN		28
89	MEZZ_TX_DP_C[0]	GND-9		29
90	MEZZ_TX_DN_C[0]	GND-10		30
91	GND-36	MEZZ_RX_DP[0]		31
92	GND-37	MEZZ_RX_DN[0]		32
93	MEZZ_TX_DP_C[1]	GND-11		33
94	MEZZ_TX_DN_C[1]	GND-12		34
95	GND-38	MEZZ_RX_DP[1]		35
96	GND-39	MEZZ_RX_DN[1]		36
97	MEZZ_TX_DP_C[2]	GND-13		37
98	MEZZ_TX_DN_C[2]	GND-14		38
99	GND-40	MEZZ_RX_DP[2]		39
100	GND-41	MEZZ_RX_DN[2]		40
101	MEZZ_TX_DP_C[3]	GND-15		41
102	MEZZ_TX_DN_C[3]	GND-16		42
103	GND-42	MEZZ_RX_DP[3]		43
104	GND-43	MEZZ_RX_DN[3]		44
105	MEZZ_TX_DP_C[4]	GND-17		45
106	MEZZ_TX_DN_C[4]	GND-18		46
107	GND-44	MEZZ_RX_DP[4]		47
108	GND-45	MEZZ_RX_DN[4]		48
109	MEZZ_TX_DP_C[5]	GND-19		49
110	MEZZ_TX_DN_C[5]	GND-20		50
111	GND-46	MEZZ_RX_DP[5]		51
112	GND-47	MEZZ_RX_DN[5]		52
113	MEZZ_TX_DP_C[6]	GND-21		53
114	MEZZ_TX_DN_C[6]	GND-22		54
115	GND-48	MEZZ_RX_DP[6]		55
116	GND-49	MEZZ_RX_DN[6]		56
117	MEZZ_TX_DP_C[7]	GND-23		57
118	MEZZ_TX_DN_C[7]	GND-24		58
119	GND-50	MEZZ_RX_DP[7]		59
120	GND-51	MEZZ_RX_DN[7]		60
	GND-52/MEZZ_PRSENT2_N	GND-25		

FCI PCIe Connector - Plug

B.2 I²C-compatible Connector Pinout

A three hole footprint for I2C Harness is provided as the I2C-compatible interface.

Figure 11: Compatible Connector Plug and Pinout

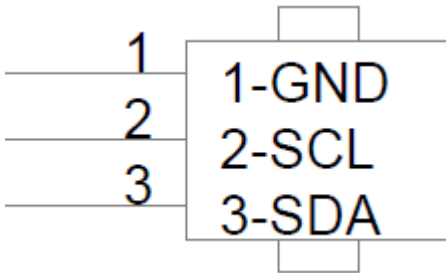
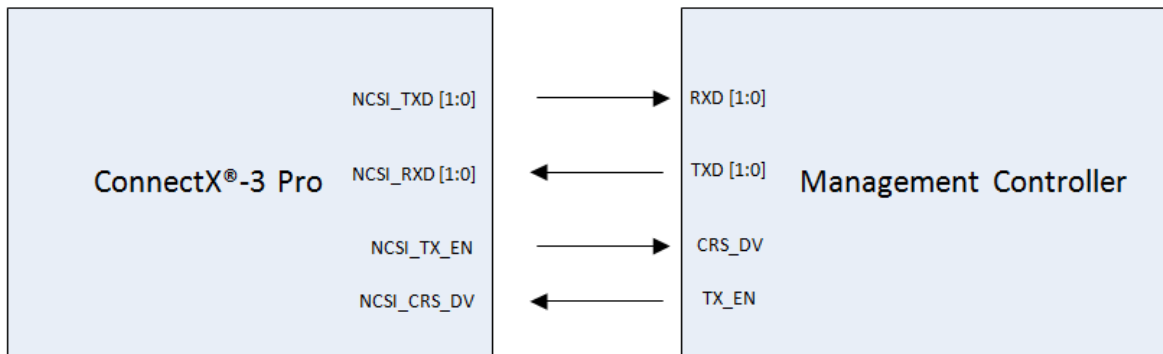

Table 11 - I2C-compatible Connector Pinout

Connector Pin Number	Signal Name
1	GND
2	SCL
3	SDA

B.3 NC-SI Interface Pinout

Figure 12: NC-SI Interface Pinout



Appendix C: Safety Warnings

For safety warnings in French see “Avertissements de sécurité d’installation (Warnings in French)” on page 34. For safety warnings in German see “Sicherheitshinweise (Warnings in German)” on page 36. For safety warnings in Spanish see “Advertencias de seguridad para la instalación (Warnings in Spanish)” on page 38.

1. Installation Instructions



Read all installation instructions before connecting the equipment to the power source.

2. Over-temperature



This equipment should not be operated in an area with an ambient temperature exceeding the maximum recommended: 55°C (131°F).

To guarantee proper air flow, allow at least 8cm (3 inches) of clearance around the ventilation openings.

3. During Lightning - Electrical Hazard



During periods of lightning activity, do not work on the equipment or connect or disconnect cables.

4. Equipment Disposal



Disposal of this equipment should be in accordance to all national laws and regulations.

5. Local and National Electrical Codes



This equipment should be installed in compliance with local and national electrical codes.

6. Hazardous Radiation Exposure



Caution – Use of controls or adjustment or performance of procedures other than those specified herein may result in hazardous radiation exposure.



CLASS 1 LASER PRODUCT and reference to the most recent laser standards:
IEC 60 825-1:1993 + A1:1997 + A2:2001 and EN 60825-1:1994+A1:1996+
A2:2001

Appendix D: Avertissements de sécurité d'installation (Warnings in French)

1. Instructions d'installation



Lisez toutes les instructions d'installation avant de brancher le matériel à la source d'alimentation électrique.

2. Température excessive



Ce matériel ne doit pas fonctionner dans une zone avec une température ambiante dépassant le maximum recommandé de 55°C (131°F). Un flux d'air de 200LFM à cette température ambiante maximale est nécessaire. En outre, pour garantir un bon écoulement de l'air, laissez au moins 8 cm (3 pouces) d'espace libre autour des ouvertures de ventilation.

3. Orages – dangers électriques



Pendant un orage, il ne faut pas utiliser le matériel et il ne faut pas brancher ou débrancher les câbles.

4. Installation du matériel



Ce matériel ne doit être installé, remplacé ou entretenu que par du personnel formé et qualifié.

5. Elimination du matériel



L'élimination de ce matériel doit s'effectuer dans le respect de toutes les législations et réglementations nationales en vigueur.

6. Codes électriques locaux et nationaux



Ce matériel doit être installé dans le respect des codes électriques locaux et nationaux.

7. Exposition au rayonnement grave



Mise en garde – l'utilisation de commandes ou de réglages ou l'exécution de procédures autres que ce qui est spécifié dans les présentes peut engendrer une exposition au rayonnement grave.



PRODUIT LASER DE CLASSE 1 » et références aux normes laser les plus récentes CEI 60 825-1:1993 + A1:1997 + A2:2001 et NE 60825-1:1994+A1:1996+ A2:2001

Appendix E: Sicherheitshinweise (Warnings in German)

1. Installationsanleitungen



Lesen Sie alle Installationsanleitungen, bevor Sie das Gerät an die Stromversorgung anschließen.

2. Übertemperatur



Dieses Gerät sollte nicht in einem Bereich mit einer Umgebungstemperatur über der maximal empfohlenen Temperatur von 55°C (131°F) betrieben werden. Es ist ein Luftstrom von 200 LFM bei maximaler Umgebungstemperatur erforderlich. Außerdem sollten mindestens 8 cm (3 in.) Freiraum um die Belüftungsöffnungen sein, um einen einwandfreien Luftstrom zu gewährleisten.

3. Bei Gewitter - Elektrische Gefahr



Arbeiten Sie während eines Gewitters und Blitzschlag nicht am Gerät, schließen Sie keine Kabel an oder ab.

4. Geräteinstallation



Diese Gerät sollte nur von geschultem und qualifiziertem Personal installiert, ausgetauscht oder gewartet werden.

5. Geräteentsorgung



Die Entsorgung dieses Geräts sollte unter Beachtung aller nationalen Gesetze Bestimmungen erfolgen.

6. Regionale und nationale elektrische Bestimmungen



Dieses Gerät sollte unter Beachtung der regionalen und nationalen elektrischen Bestimmungen installiert werden.

7. Strahlenkontakt



Achtung – Nutzung von Steuerungen oder Einstellungen oder Ausführung von Prozeduren, die hier nicht spezifiziert sind, kann zu gefährlichem Strahlenkontakt führen..



Klasse 1 Laserprodukt und Referenzen zu den aktuellsten Lasterstandards :
ICE 60 825-1:1993 + A1:1997 + A2:2001 und EN 60825-1:1994+A1:1996+A2:2001

Appendix F: Advertencias de seguridad para la instalación (Warnings in Spanish)

1. Instrucciones de instalación



Antes de conectar el equipo a la fuente de alimentación, leer todas las instrucciones de instalación.

2. Sobrecalentamiento



No se debe utilizar el equipo en un área con una temperatura ambiente superior a la máxima recomendada: 55°C(131°F). Además, para garantizar una circulación de aire adecuada, se debe dejar como mínimo un espacio de 8 cm (3 pulgadas) alrededor de las aberturas de ventilación.

3. Cuando hay rayos: peligro de descarga eléctrica



No utilizar el equipo ni conectar o desconectar cables durante períodos de actividad de rayos.

4. Instalación de equipos



La instalación, el reemplazo y el mantenimiento de este equipo estarán a cargo únicamente de personal capacitado y competente.

5. Eliminación de equipos



La eliminación definitiva de este equipo se debe efectuar conforme a todas las leyes y reglamentaciones nacionales.

6. Códigos eléctricos locales y nacionales



Este equipo se debe instalar conforme a los códigos eléctricos locales y nacionales.

7. Exposición a niveles de radiación peligrosos



Precaución: el uso de controles o ajustes o la realización de procedimientos distintos de los que aquí se especifican podrían causar exposición a niveles de radiación peligrosos.



PRODUCTO LÁSER DE CLASE 1 y referencia a las normas de láser más recientes:
IEC 60825-1:2007/03 y EN 60825-1:2007